

Lower Rails – Extruded Aluminum.....	2-1
Stoughton.....	2-1
Lower Rails.....	2-4
Dorsey.....	2-4
Fruehauf.....	2-4
Hyundai.....	2-6
Monon.....	2-6
Pines.....	2-7
Strick.....	2-7
Trailmobile.....	2-7
Utility.....	2-8
Wabash.....	2-8
Upper Rails – Extruded Aluminum.....	2-10
Stoughton.....	2-10
Upper Rails.....	2-11
Dorsey.....	2-11
Great Dane.....	2-11
Great Dane.....	2-12
Hyundai.....	2-12
Monon.....	2-13
Pines.....	2-13
Strick.....	2-13
Trailmobile.....	2-14
Utility.....	2-14
Vanguard Trailers.....	2-14
Wabash.....	2-15
Splices – Lower Rails.....	2-16
Stoughton.....	2-16
Splices – Upper Rails.....	2-17
Stoughton.....	2-17
Lift Pads.....	2-17
Stoughton.....	2-17
Upper Rail Guards.....	2-18
Stoughton.....	2-18
Sidewall Extrusions.....	2-18
Stoughton.....	2-18

Dorsey.....	2-18
Sidewall Posts – Extruded Aluminum.....	2-19
Stoughton.....	2-19
Great Dane .....	2-19
Wabash.....	2-19
Sidewall Posts – Rolled Steel.....	2-20
Stoughton – Rolled Steel .....	2-20
Sidewall Posts – Logistics Posts .....	2-22
Stoughton.....	2-22
Plate Van Splice Plates .....	2-23
Stoughton.....	2-23
Sidewall Posts .....	2-24
Dorsey.....	2-24
Fruehauf.....	2-24
Great Dane .....	2-24
Hyundai.....	2-26
Manac .....	2-27
Monon .....	2-27
Pines .....	2-27
Strick.....	2-28
Trailmobile.....	2-29
Utility .....	2-31
Wabash.....	2-33
Nose Panels .....	2-35
Stoughton.....	2-35
Sidewall Panels .....	2-35
Stoughton.....	2-35
Dorsey.....	2-37
Fruehauf.....	2-38
Great Dane .....	2-38
Manac .....	2-40
Trailmobile.....	2-41
Utility .....	2-41
Wabash.....	2-43
Scuff Liners and Wall Liners.....	2-44
Stoughton.....	2-44
Miscellaneous.....	2-47
Stoughton.....	2-47

## LOWER RAILS – EXTRUDED ALUMINUM

Stoughton

**Note:** Upper and Lower Rails are NOT available punched.  
 The last five digits in the part number indicates length in inches.  
 For example:  
 000-12 = cut per foot  
 624-12 = 624 1/8"

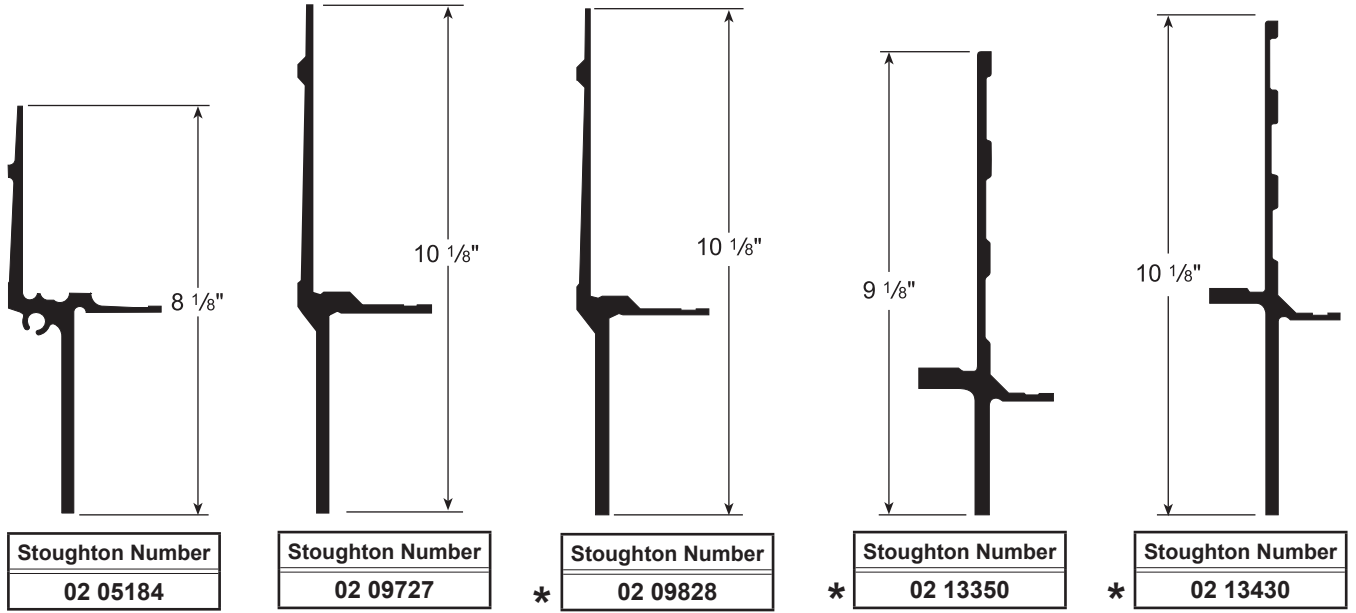

\* Container only  
 Replaces 02 11921

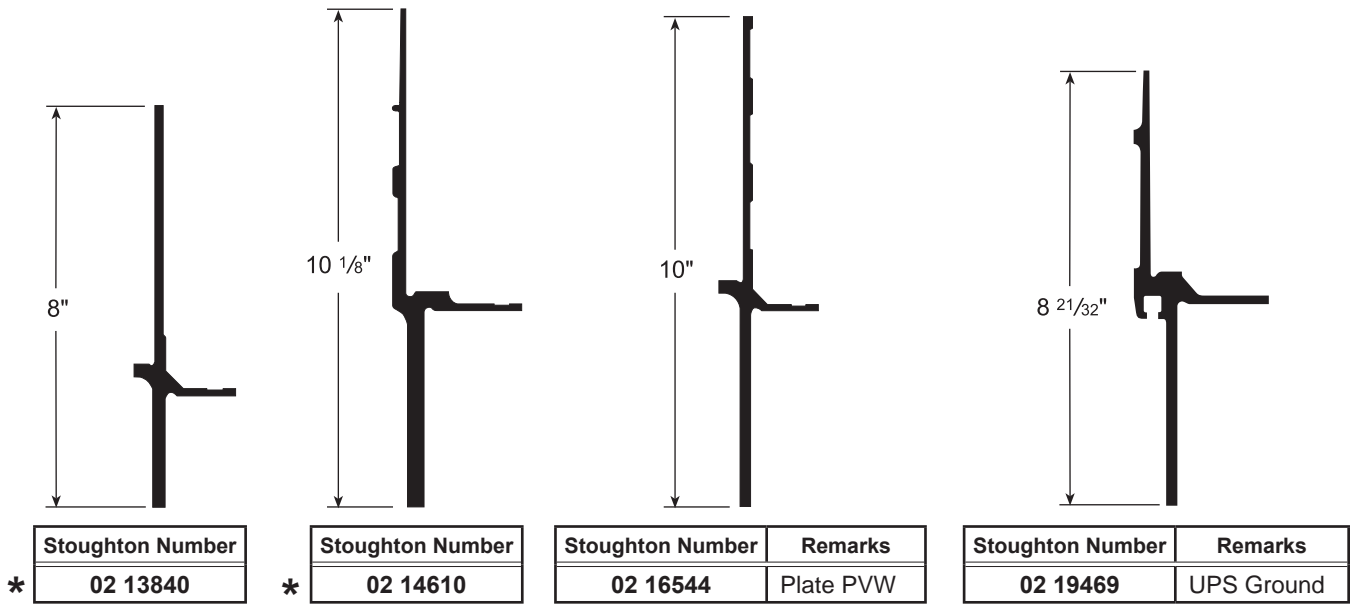

\* Refers to Container

## LOWER RAILS – EXTRUDED ALUMINUM

Stoughton

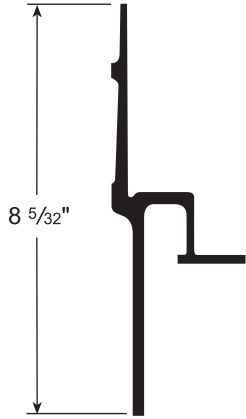

Stoughton Number	Remarks
02 20021	FedEx Ground

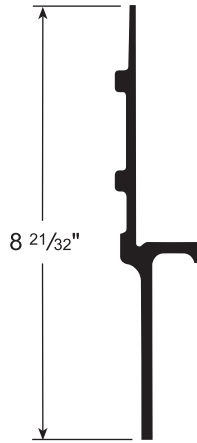

Stoughton Number	Remarks
02 20022	FedEx Ground

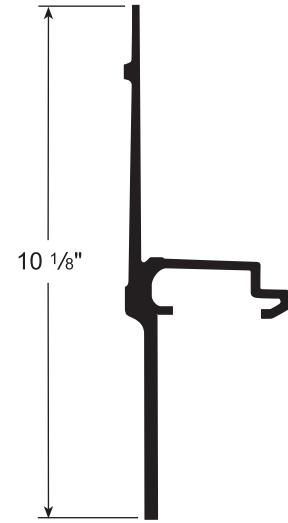

Stoughton Number	Remarks
02 20498	AVW

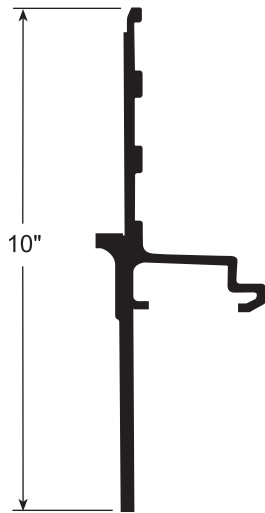

Stoughton Number	Remarks
02 20572	ZPVW - 1st Gen. Z-plate
02-22839	ZGPVW - 2nd Gen Z-plate
2PVW	Tough Plate
2C-PVW	3 Piece Bottom Rail

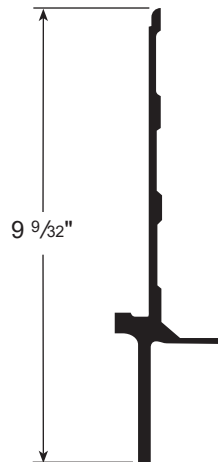

Stoughton Number	Remarks
02 22154	Schneider Container

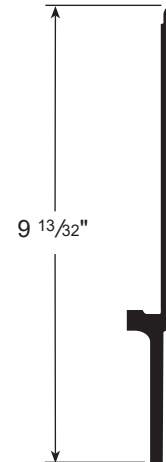

Stoughton Number	Remarks
02 22400	Schneider Container

## LOWER RAILS – EXTRUDED ALUMINUM

Stoughton

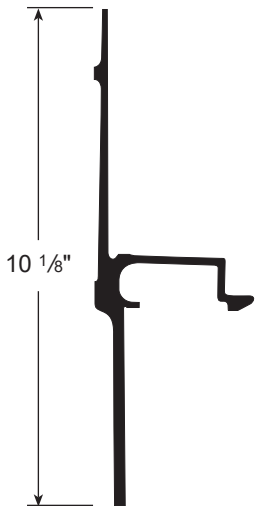

Stoughton Number	Remarks
02 22823	AVW

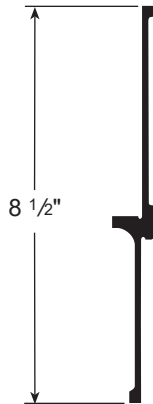

Stoughton Number	Remarks
02 24154	Top

ZTPVW "Tough Plate" Top Extrusion

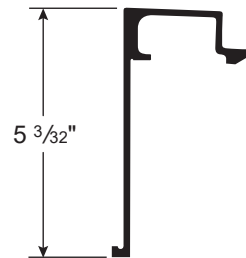

Stoughton Number	Remarks
02 24169	Bottom

ZTPVW "Tough Plate" Bottom Extrusion

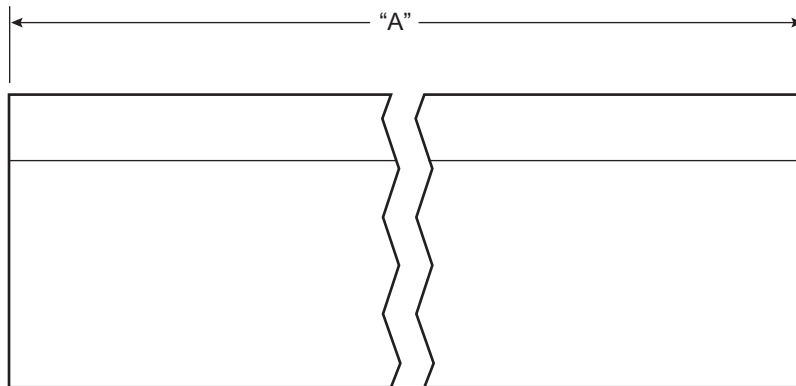

Stoughton Number	"A"	Remarks
04 24346 003	623 1/2"	18" Plate
04 24346 002	563 1/2"	18" Plate
04 24346 001	527 1/2"	18" Plate

ZTPVW "Tough Plate" Bottom Plate

## LOWER RAILS

### Dorsey

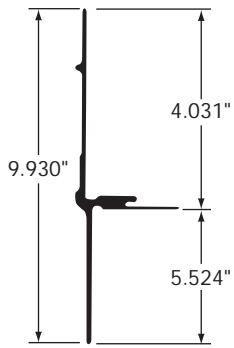

LOWER RAIL, 618"

Stoughton Number
DOR-2511068

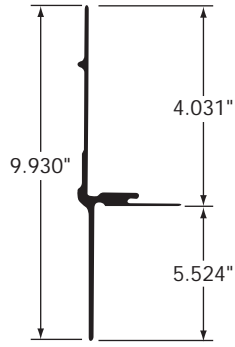

LOWER RAIL, 558"

Stoughton Number
DOR-2511068-558

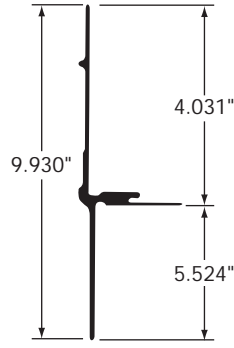

LOWER RAIL

Stoughton Number
DOR-2511203



LOWER RAIL, 618"

Stoughton Number
DOR-2511230-568

### Fruehauf

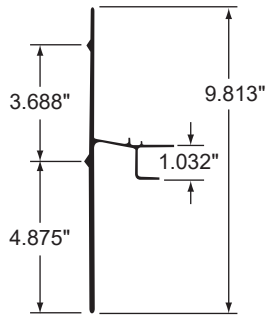

LOWER RAIL

Stoughton Number
FRU#STK21038-47

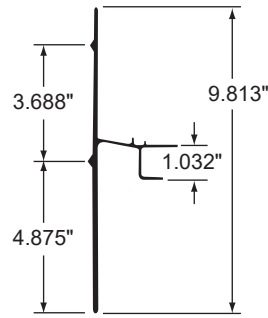

LOWER RAIL, EXTRU, 625"

Stoughton Number
FRU#STK21038-52

## LOWER RAILS Great Dane

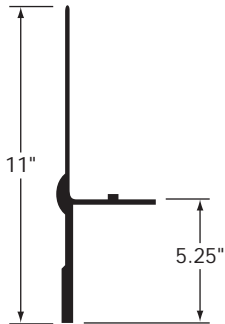

LOWER RAIL, EXTRU, 624"

Stoughton Number
GD#60307101

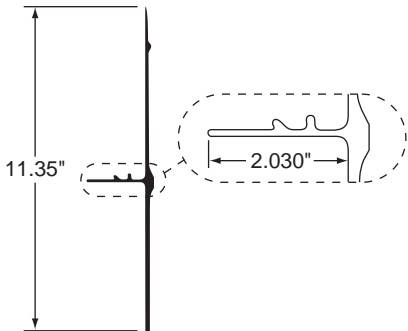

LOWER RAIL, EXTRU, 626"

Stoughton Number
GD#60308901

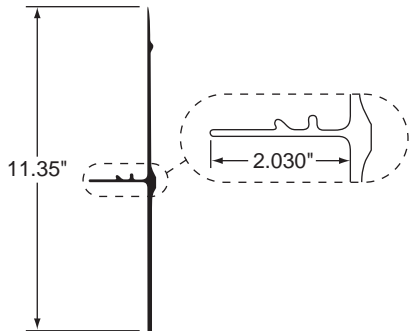

LOWER RAIL, EXTRU, 327"

Stoughton Number
GD#60308901-327

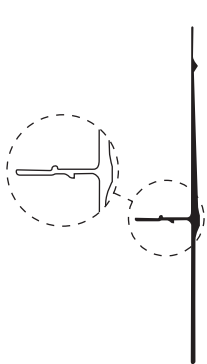

LOWER RAIL, EXTRU, 625"

Stoughton Number
GD#60312306

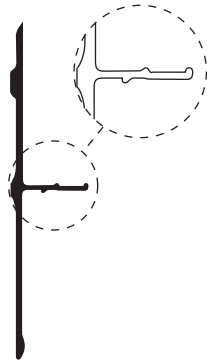

LOWER RAIL, EXTRU, 625"

Stoughton Number
GD#60315409

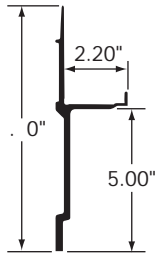

LOWER RAIL "SUPER SEAL," 621.25"

Stoughton Number
GD#4-09864-09940

## LOWER RAILS

Hyundai

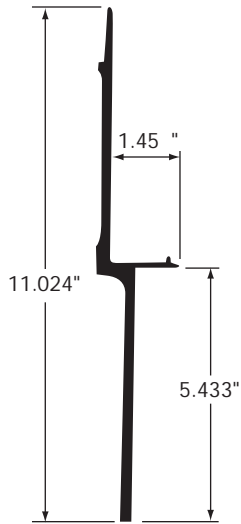

LOWER SIDE RAIL, 30.6'

Stoughton Number
HY#1000-3979

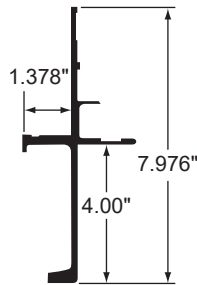

LOWER RAIL

Stoughton Number
HY#1000-4707

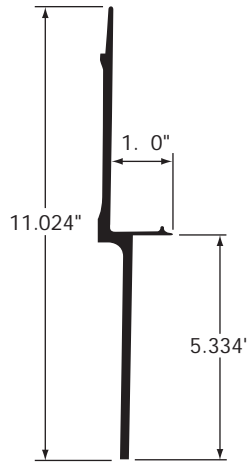

LOWER RAIL

Stoughton Number
HY#1000-4711

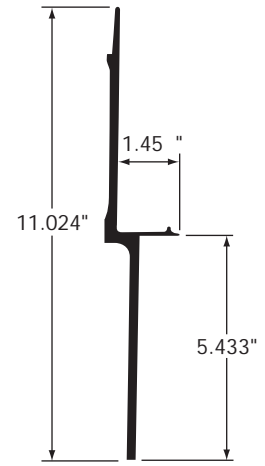

BOTTOM RAIL

Stoughton Number
HY#1000-4717



LOWER RAIL

Stoughton Number
HY#1000-5678

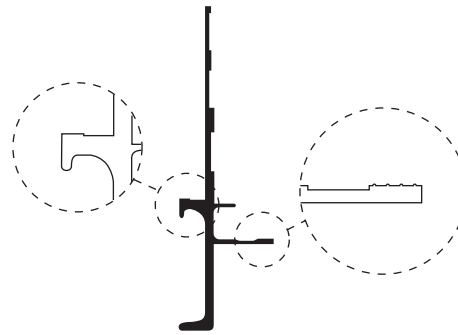

LOWER RAIL CONTAINER

Stoughton Number
HY#1001-5731

## Monon

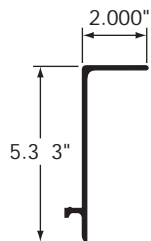

LOWER RAIL

Stoughton Number
MON-AB039418

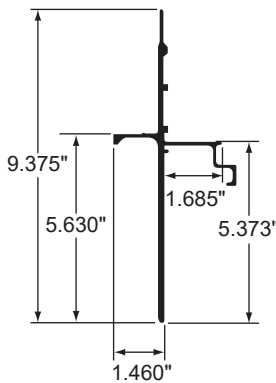

LOWER RAIL, EXTERIOR POST

Stoughton Number
MON-AX054359

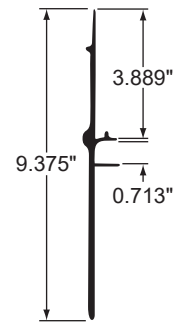

LOWER RAIL, INTERIOR POST

Stoughton Number
MON-AX054380



## LOWER RAILS Pines

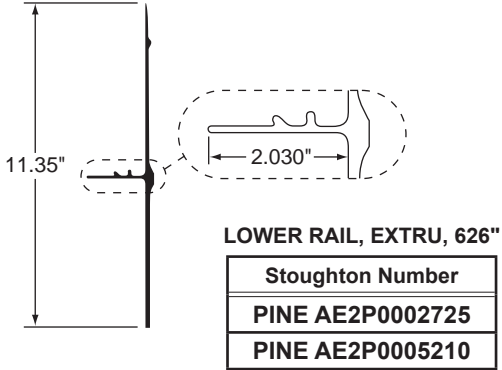
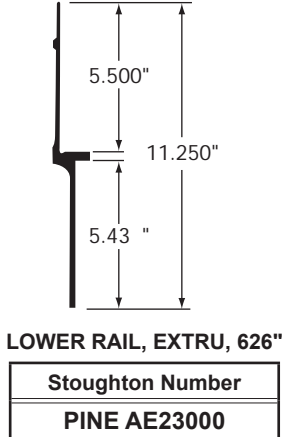

## Strick

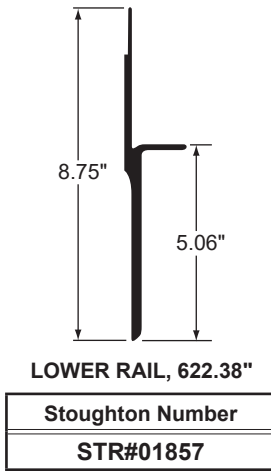
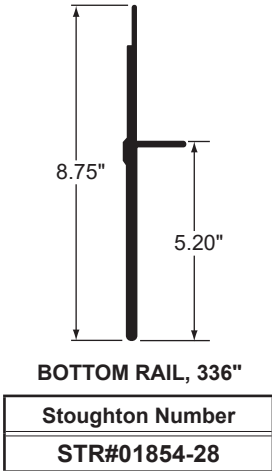
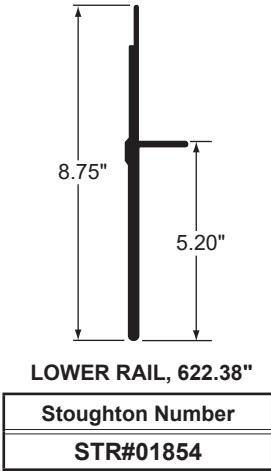

## Trailmobile

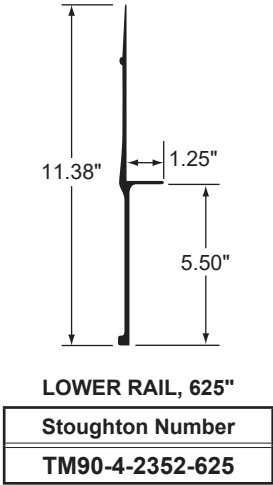
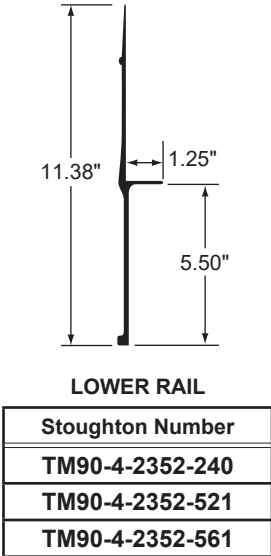

# LOWER RAILS

## Utility

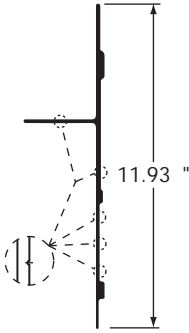

LOWER RAIL, ALUM, 2000R, 561.5"

Stoughton Number
UT-01-6650-0-061

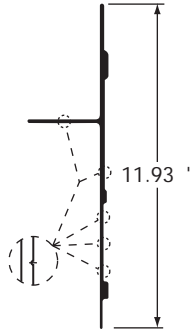

LOWER RAIL, ALUM, 2000R, 408"

Stoughton Number
UT-01-6650-0-062

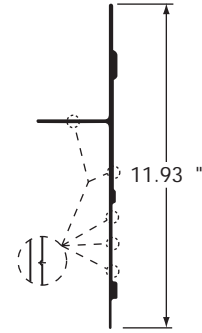

LOWER RAIL, ALUM, 2000R, 621.5"

Stoughton Number
UT-01-6650-0-091

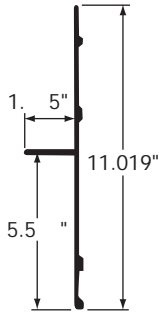

LOWER RAIL, 3000R, 625"

Stoughton Number
UT-01-6650-0-149

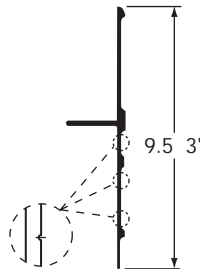

LOWER RAIL, 3000R, WITH 4" X-MEMBER, HD

Stoughton Number
UT-01-6650-0-167



BOTTOM RAIL

Stoughton Number
UT-01-6650-0-190

## Wabash

### Aluminum Repair Plate for High Baseraill

0.190" x 22" x A

A = 624.5"

LOWER RAIL, 5" MILL

Stoughton Number
WAB-01106921

### Aluminum Repair Plate for High Baseraill

0.190" x 22" x A

A = 144"

LOWER RAIL

Stoughton Number
WAB-01107364

### Aluminum Repair Plate for High Baseraill

0.190" x 22" x A

A = 312"

LOWER RAIL

Stoughton Number
WAB-01107434

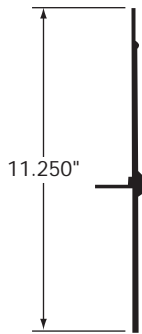

**LOWER RAIL, REEFER**

Stoughton Number
<b>WAB-E0366260</b>

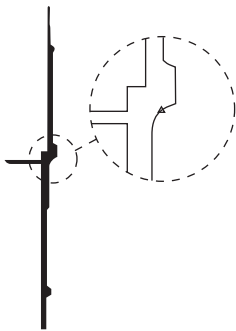

**LOWER RAIL, 108"**

Stoughton Number
<b>WAB-E3831080</b>

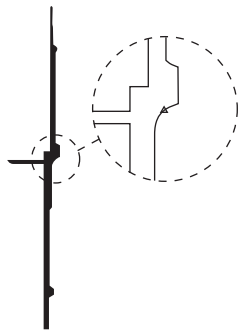

**LOWER RAIL, 324"**

Stoughton Number
<b>WAB-E3833240</b>

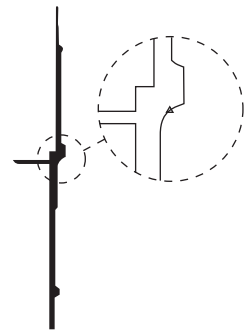

**LOWER RAIL, 626"**

Stoughton Number
<b>WAB-E3836260</b>

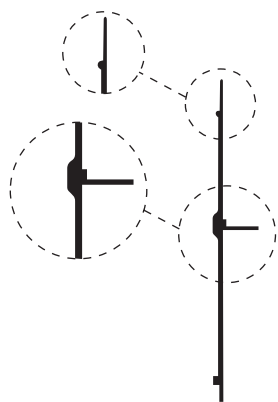

**LOWER RAIL, 626"**

Stoughton Number
<b>WAB-E7026260</b>

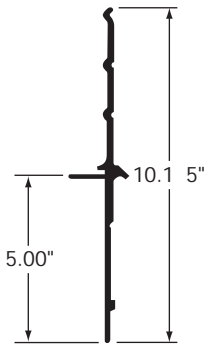

**DURAPLATE LOWER RAIL, 108"**

Stoughton Number
<b>WAB-E7321080</b>

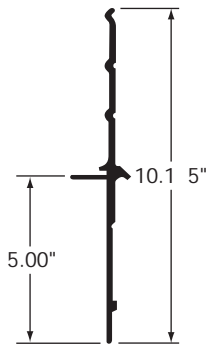

**DURAPLATE LOWER RAIL, 324"**

Stoughton Number
<b>WAB-E7323240</b>

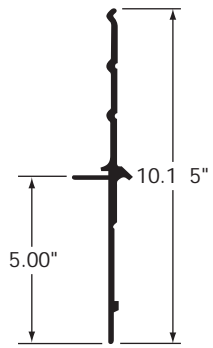

**DURAPLATE LOWER RAIL, 626"**

Stoughton Number
<b>WAB-E7326260</b>

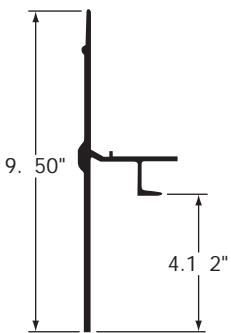

**BOTTOM RAIL, SHEET AND POST**

Stoughton Number
<b>WAB-E8116260</b>

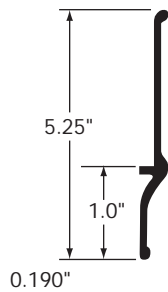

**LOWER RAIL**

Stoughton Number
<b>WAB-E9966260</b>

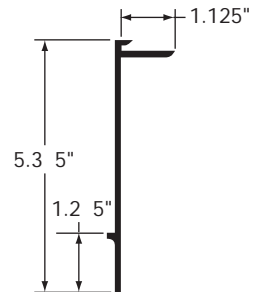

**LOWER RAIL**

Stoughton Number
<b>WAB-E9976260</b>

"Dorsey," "Fruehauf," "Great Dane," "Hyundai," "Kentucky," "Lufkin," "Monon," "Manac," "Pines," "Strick," "Trailmobile," "Utility," "Vanguard Trailer," and "Wabash" are trademarks of their respective owners and are used only to identify corresponding part numbers of Stoughton Part Sales, LLC. Stoughton Part Sales, LLC is not affiliated with the owners of these trademarks.

## UPPER RAILS – EXTRUDED ALUMINUM

Stoughton

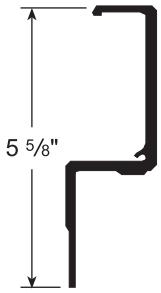

Stoughton Number
02 04795

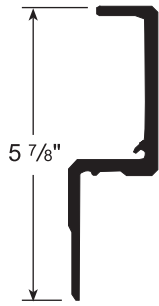

Stoughton Number	Remarks
02 06388	AVW

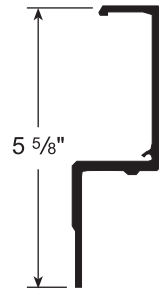

Stoughton Number	Remarks
02 06831	DVW

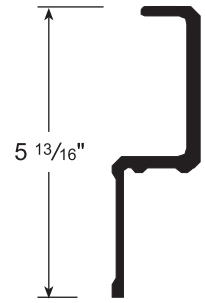

Stoughton Number
* 02 10205

Replaces 02 11920

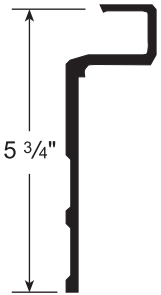

Stoughton Number
02 11132

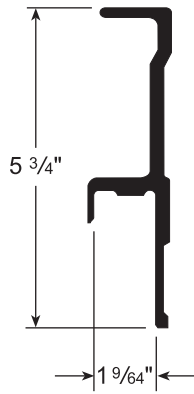

Stoughton Number
* 02 13351

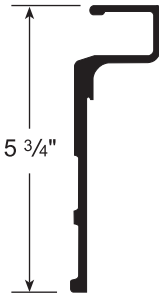

Stoughton Number
* 02 13865

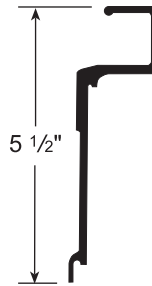

Stoughton Number
02 16545

Replaces 02 14657

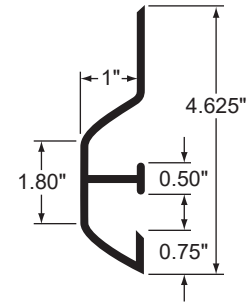

Stoughton Number
02 18804 613 50

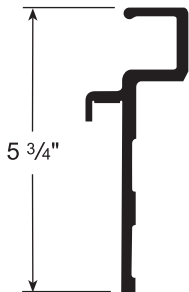

Stoughton Number
02 20573 ZPVW ZGPVW ZTPVW

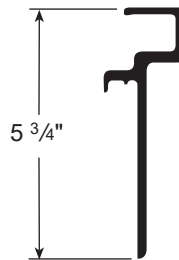

Stoughton Number	Remarks
* 02 22153	Schneider Container

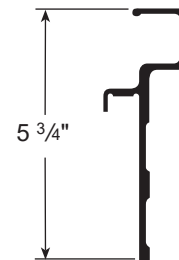

Stoughton Number	Remarks
02 22626	SEVW

\* Refers to Container

## UPPER RAILS Dorsey

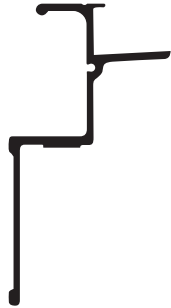

UPPER RAIL

Stoughton Number
DOR-2511202

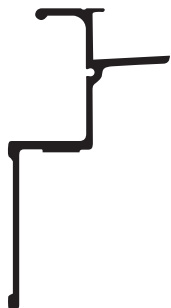

UPPER RAIL

Stoughton Number
DOR-2511074-558

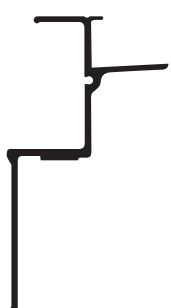

UPPER RAIL

Stoughton Number
DOR-2511208-348

## Great Dane

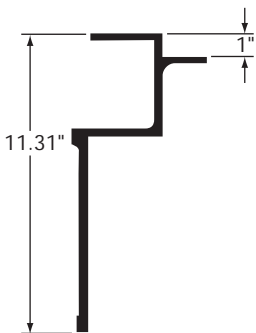

UPPER RAIL, 564"

Stoughton Number
GD#60304401

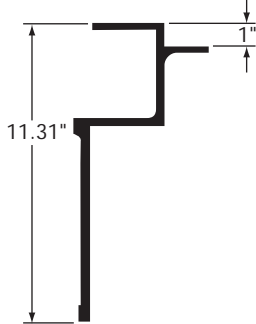

UPPER RAIL, 622"

Stoughton Number
GD#60304402

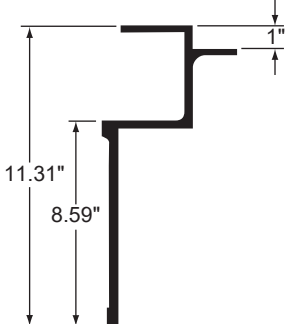

UPPER RAIL, EXTRU, 622.20"

Stoughton Number
GD#60304406

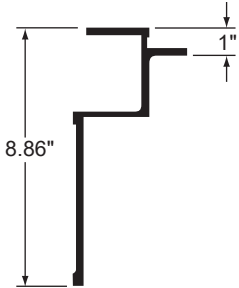

UPPER RAIL, EXTRU, 625"

Stoughton Number
GD#60309001

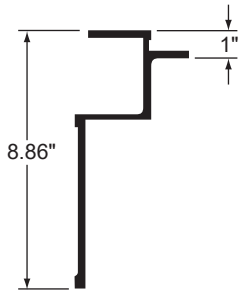

UPPER RAIL, EXTRU, 324.6"

Stoughton Number
GD#60309001-3246

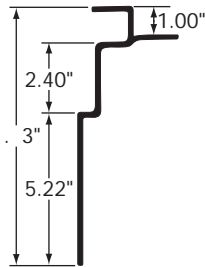

UPPER RAIL, 623.23"

Stoughton Number
GD#60311701

## UPPER RAILS

Great Dane

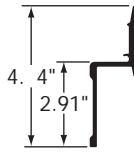

UPPER RAIL "SUPER SEAL," 621.25"

Stoughton Number
GD#4-14046-09940

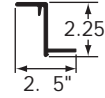

UPPER RAIL "SUPER SEAL," 620.75"

Stoughton Number
GD#4-23854-09932

## Hyundai

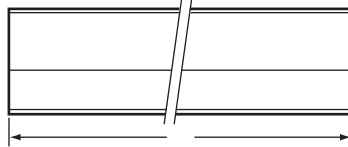
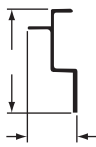

UPPER SIDE RAIL, 52'

Stoughton Number
HY#1000-3986

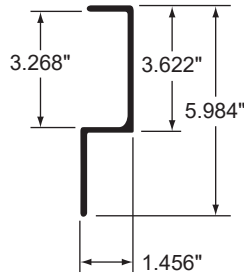

UPPER RAIL

Stoughton Number
HY#1000-4926

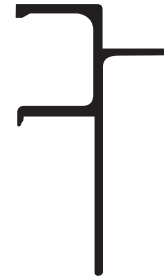

CONTAINER TOP RAIL

Stoughton Number
HY#1000-4927

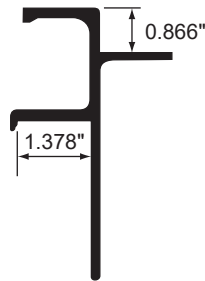

UPPER RAIL

Stoughton Number
HY#1000-6153

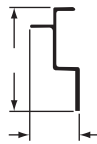

TOP RAIL, 28'

Stoughton Number
HY#1000-8568

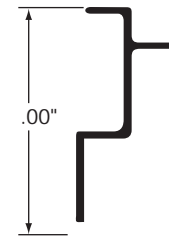

SIDE RAIL, UPPER 622"

Stoughton Number
HY#1001-5708

## UPPER RAILS Monon

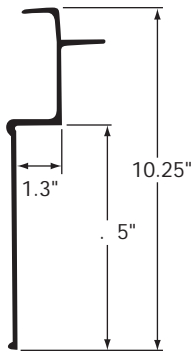

UPPER RAIL

Stoughton Number
MON-AA100140

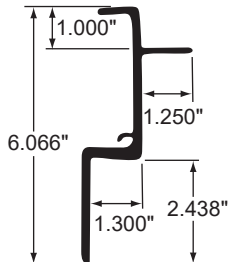

UPPER RAIL, INTERIOR POST TRLR

Stoughton Number
MON-AA100170

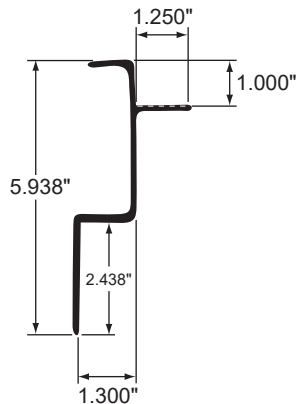

UPPER RAIL, INTERIOR

Stoughton Number
MON-AA100290

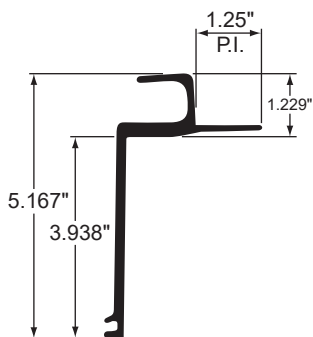

UPPER RAIL

Stoughton Number
MON-AX054345

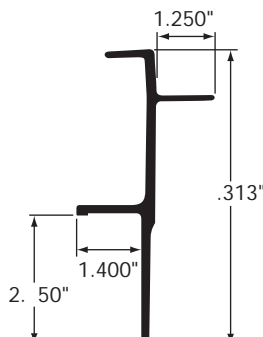

TOP RAIL, EXTERIOR POST

Stoughton Number
MON-AX054379

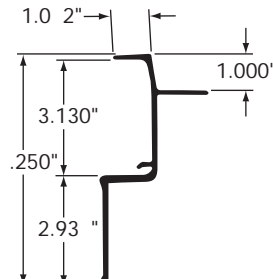

TOP RAIL

Stoughton Number
MON-V01-150

## Pines

## Strick

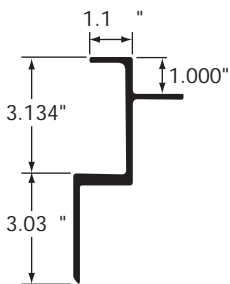

UPPER RAIL, EXTRU, 625"

Stoughton Number
PINE AE1D1005176

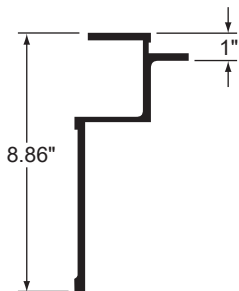

UPPER RAIL, EXTRU, 625"

Stoughton Number
PINE AE1P0002705
PINE AE1P0005205

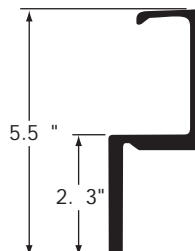

TOP RAIL, 621.38"

Stoughton Number
STR#06043

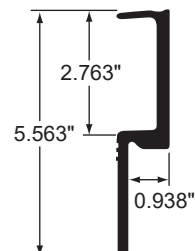

TOP RAIL, 621.38"

Stoughton Number
STR#03396

## UPPER RAILS

### Trailmobile

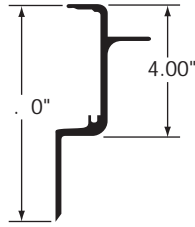

UPPER RAIL, INTERIOR POST, MODEL O

Stoughton Number
TM90-4-2305-240
TM90-4-2305-625

### Utility



TOP RAIL, 625"

Stoughton Number
UT-01-6650-0-113

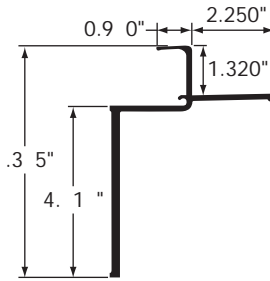

TOP RAIL, 3000R, 625"

Stoughton Number
UT-01-6650-0-150

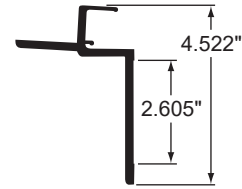

TOP RAIL

Stoughton Number
UT-01-6650-0-179

### Vanguard Trailers

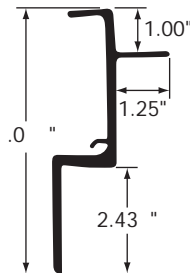

UPPER RAIL, INTERIOR POST, TRLR

Stoughton Number
VAN-EXT0002-3660
VAN-EXT0002-621M



## UPPER RAILS Wabash

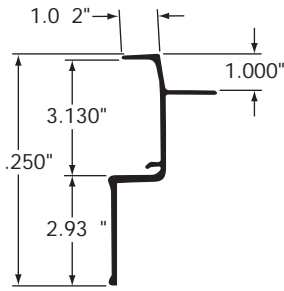

UPPER RAIL, UNIV, 9'

Stoughton Number
WAB-E0011080

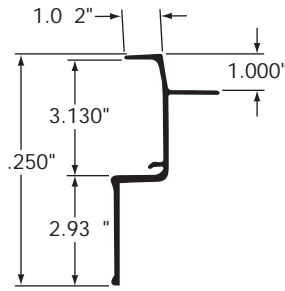

UPPER RAIL, UNIV, 27'

Stoughton Number
WAB-E0013240

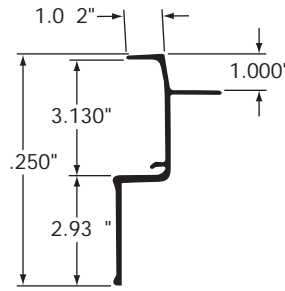

UPPER RAIL, UNIV, 52'

Stoughton Number
WAB-E0016260

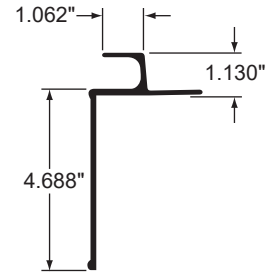

UPPER RAIL, 9'

Stoughton Number
WAB-E0071080

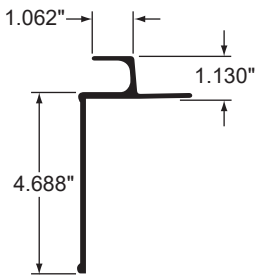

UPPER RAIL, 27'

Stoughton Number
WAB-E0073240

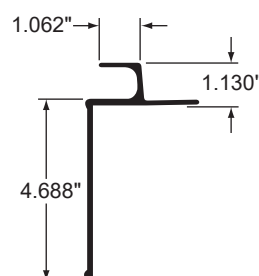

UPPER RAIL, 52'

Stoughton Number
WAB-E0076260

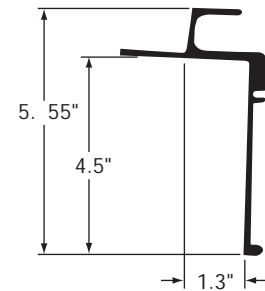

TOP RAIL, HD W/WIRE GROOVE, DURA-PLATE 9'

Stoughton Number
WAB-E0531080

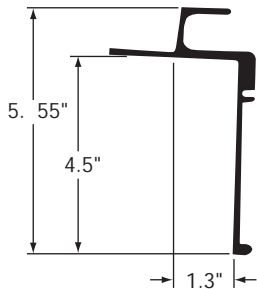

TOP RAIL, HD W/WIRE GROOVE, DURA-PLATE 52'

Stoughton Number
WAB-E0536260

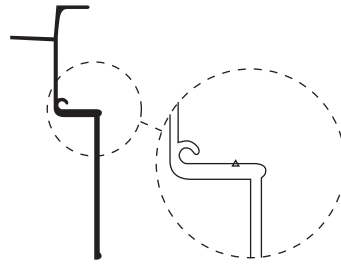

UPPER RAIL, 108"

Stoughton Number
WAB-E0551080

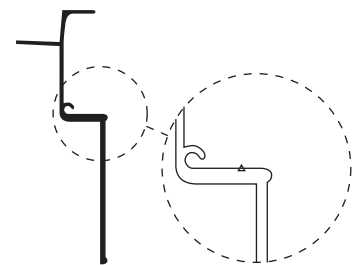

UPPER RAIL, 324"

Stoughton Number
WAB-E0553240

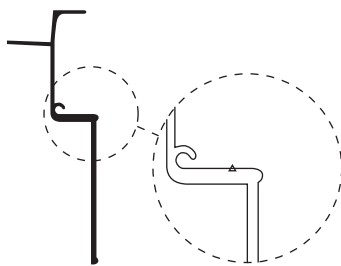

UPPER RAIL, 626"

Stoughton Number
WAB-E0556260

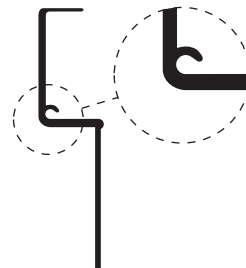

UPPER RAIL, 626"

Stoughton Number
WAB-E3226260

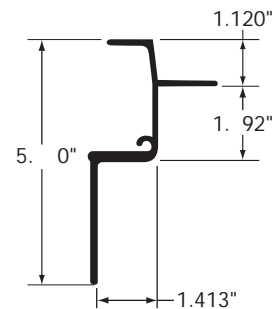

TOP RAIL

Stoughton Number
WAB-E8216260

## SPLICES – LOWER RAILS

Stoughton

### Lower Rail Splice Procedure

- Do not weld on the lower rail.
- On radius front trailers, the splice is to be made 8" forward of the centerline of a sidewall post.
- On bevel front trailers, the splice is to be made 10 3/8" forward of the centerline of a sidewall post.
- On containers, the splice is to be made 12" forward of the centerline of a sidewall post.

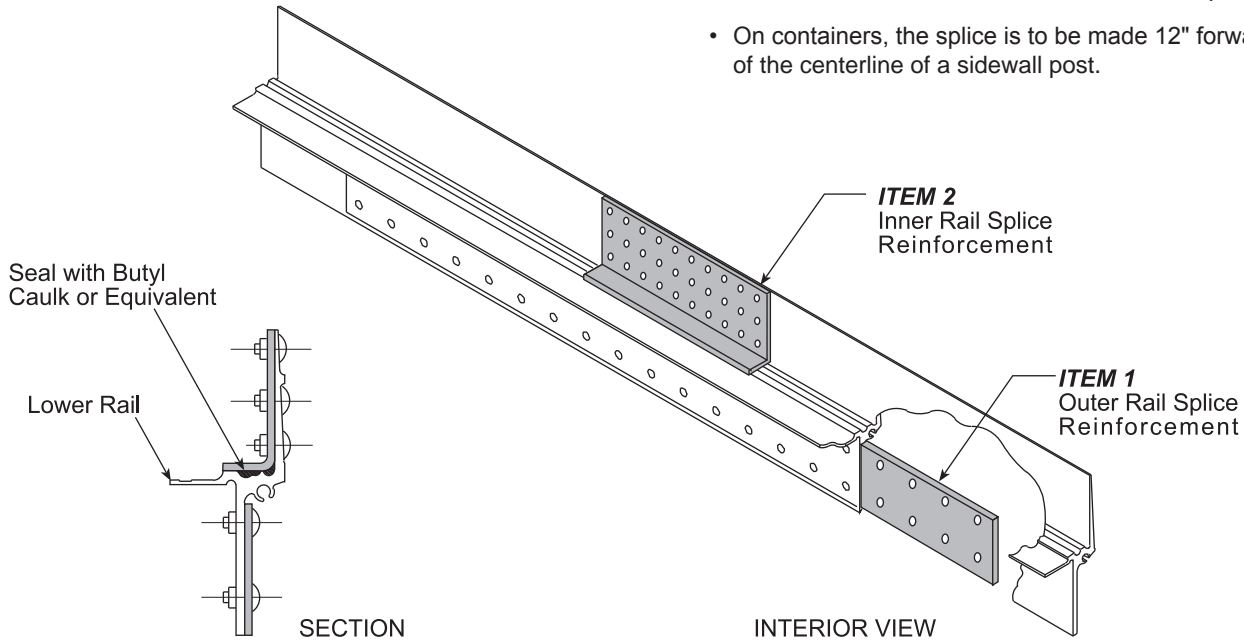

If Lower Rail Extrusion is:	The Stoughton Number for Item 1 is:	The Stoughton Number for Item 2 is:
02 05184	01 07983	01 07476
02 09727	01 07983	01 10651
02 09828	01 07983	01 10651
02 16544	01 07983	01 15806
02 20498	01 21901	01 23032
02 20548	01 21901	01 23032
02 22823	01 21901	01 23032
02 22843	01 21901	01 23032

If Lower Rail Extrusion is:	The Stoughton Number for the Top Outer Rail Splice Reinforcement is:	The Stoughton Number for the Lower Outer Rail Splice Reinforcement is:	Remarks
02 20572	01 21901	01 21746	No Inner Splice Reinforcement Needed
02 22839	01 20901	01 21746	No Inner Splice Reinforcement Needed

\* Refers to Container

## SPLICES – UPPER RAILS

Stoughton

### Upper Rail Splice Procedure

- Do not weld on the upper rail.
- The splice is to be made between two roof bows.
- Holes for fasteners are to be transfer drilled.

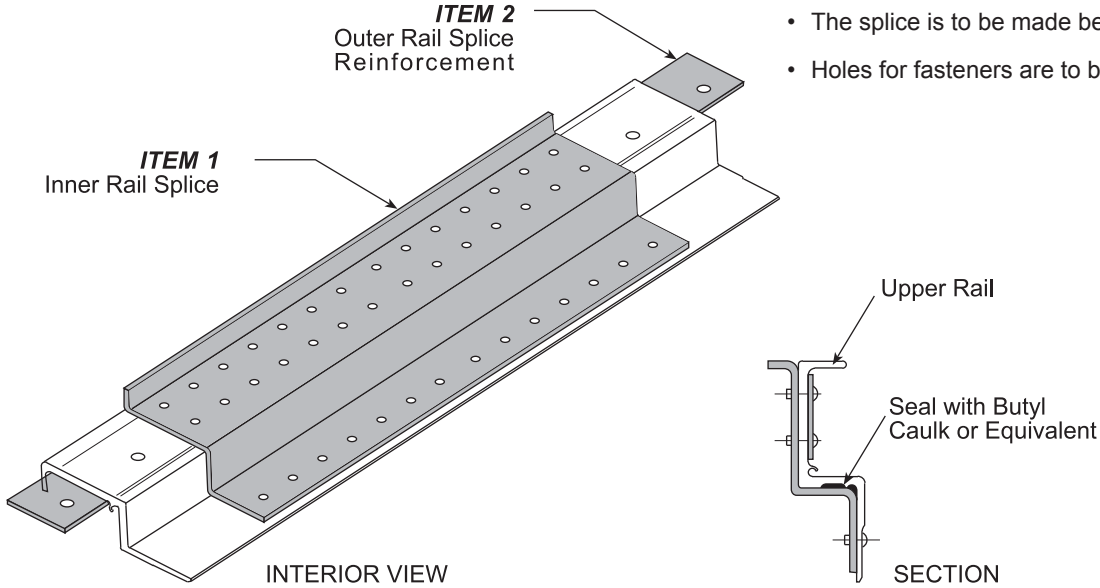

	If Upper Rail Extrusion is:	The Stoughton Number for Item 1 is:	The Stoughton Number for Item 2 is:
*	02 06388	01 07544	01 07979
	02 06831	01 07544	01 07979
	02 10205	01 10658	01 10640
	02 20573	01 21745	01 21923

See Section 15 for more Container Rails

## LIFT PADS

Stoughton

**NOTE:** Lift Pads are specific for rail extrusion.

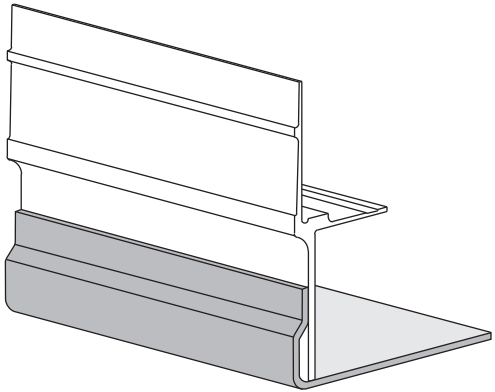

### INTERMEDIATE

Stoughton Number	Length	Remarks
01 08004 100 00	112"	Roadside
01 08004 200 00	112"	Curbside
* 01 12168 000 00	36"	
01 11627 000 00	120"	
01 11627 001 00	60"	

**NOTE:** "Universal" lift pads do not compare to OE for fit, form, function, and durability.

Call with VIN (Serial Number) for correct application

\* Refers to Container

## UPPER RAIL GUARDS

Call with trailer VIN (Serial Number) for correct application

Stoughton

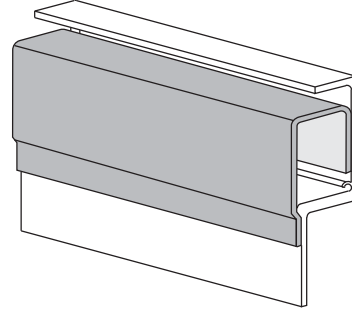
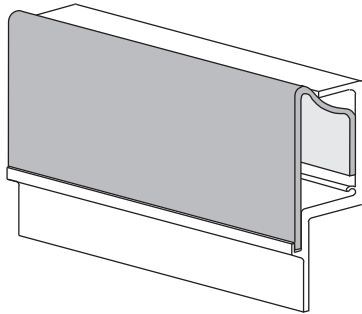

Stoughton Number	Length	Remarks
01 13943 000 00	95 7/8"	UPS
01 19661 000 00	96"	

Stoughton Number	Length
* 01 10315 000 00	72"
* 01 11904 000 00	108"
* 01 15352 000 00	108"

## SIDEWALL EXTRUSIONS

Stoughton

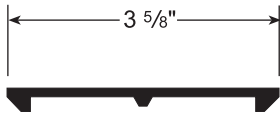

EDGE CLOSURE

Stoughton Number	Remarks
02 04306	Aluminum

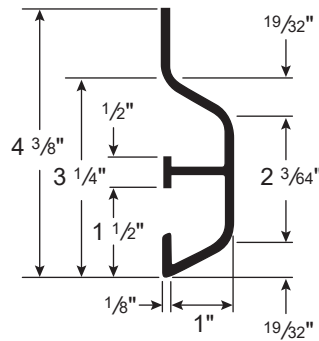

RUB RAIL

Stoughton Number	Remarks
02 18804 613 50	End Caps – 04 21987 000 00

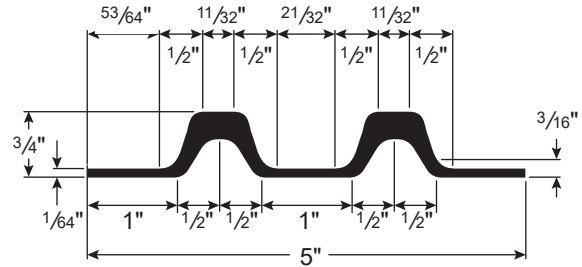

RUB RAIL

Stoughton Number	Remarks
02 19470 314 00	UPS Style

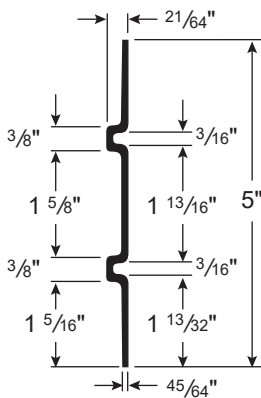

RUB RAIL

Stoughton Number	Remarks
02 20066 322 38	FedEx Style

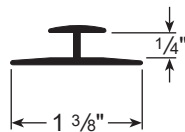

PLYWOOD DIVIDER

Stoughton Number	Length	Remarks
AS 4713	96"	Aluminum

Dorsey



RUB RAIL

Stoughton Number
DOR-2511232-348

\* Refers to Container

## SIDEWALL EXTRUSIONS

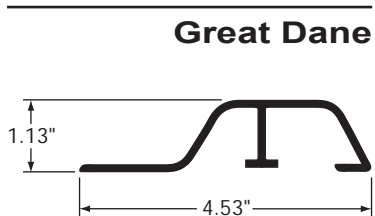

RUB RAIL, ALUMINUM, 51.1'

Stoughton Number
GD#60314403

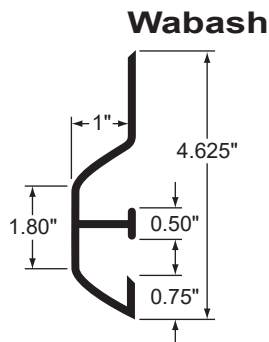

RUB RAIL

Stoughton Number
WAB-E0766130

## SIDEWALL POSTS – EXTRUDED ALUMINUM

Stoughton

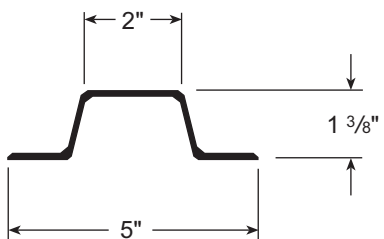

Stoughton Number	Length	Remarks
01 13208 015 02	110"	Punched
02 04793 110 00	110"	
02 04793 125 00	125"	

03-16930 (galvanized) can be substituted

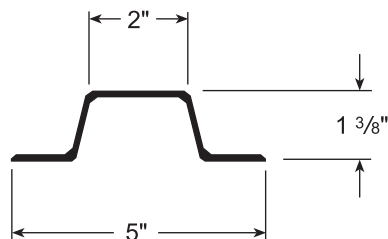

Stoughton Number	Length
02 04793 110 00	110"

03-16930 (galvanized) can be substituted

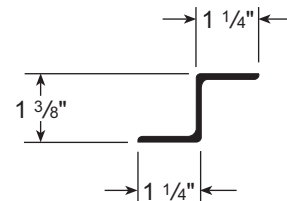

Stoughton Number	Length
02 04922 108 75	108 3/4"
02 04922 126 75	126 3/4"

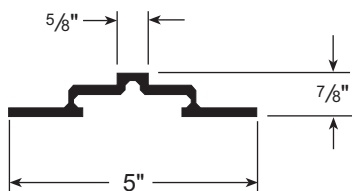

Stoughton Number	Length
02 06517 109 75	109 3/4"

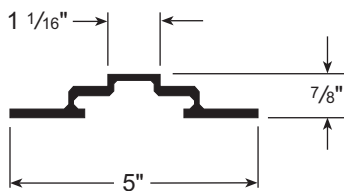

Stoughton Number	Length
02 06902 111 12	111 1/8"

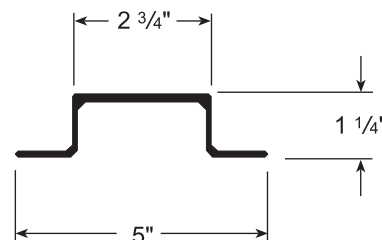

Stoughton Number	Length
* 02 09859 110 00	110"

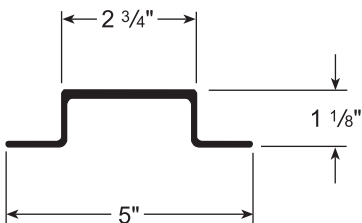

Stoughton Number	Length
* 02 11321 105 63	105 5/8"

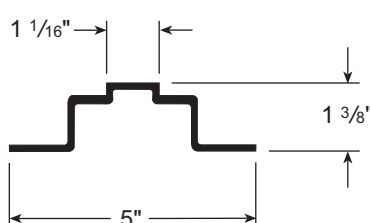

Stoughton Number	Length
02 11815 109 25	109 1/4"

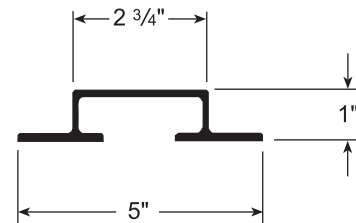

Stoughton Number	Length
* 02 13352 110 00	110"

\* Refers to Container

## SIDEWALL POSTS – EXTRUDED ALUMINUM

Stoughton

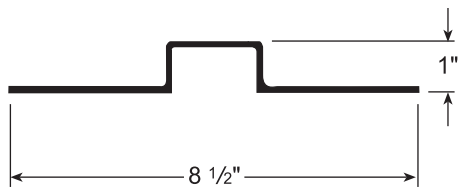

Stoughton Number	Length
* 02 13503 110 00	110"

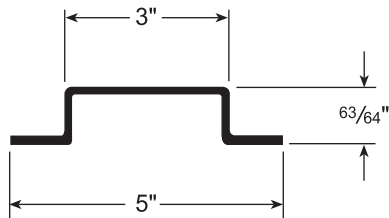

Stoughton Number	Length
02 14396 096 00	96"

"Capping Post" for 02-13352 and 02-19144

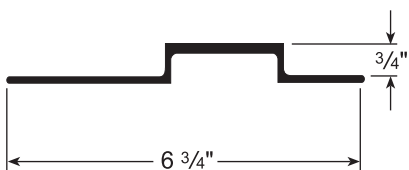

Stoughton Number	Length
* 02 14899 105 31	105 5/16"

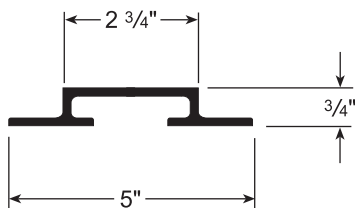

Stoughton Number	Length
* 02 14900 110 00	110"

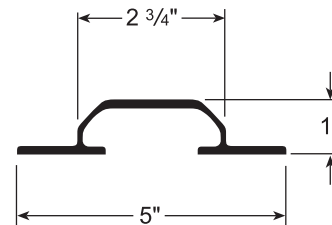

Stoughton Number	Length
* 02 19144 107 56	107 9/16"

## SIDEWALL POSTS – ROLLED STEEL

Stoughton – Rolled Steel

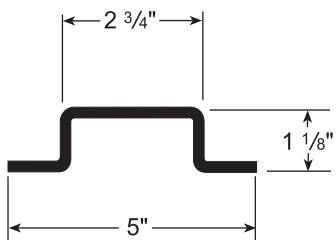

Stoughton Number
* 03 12613 105 62

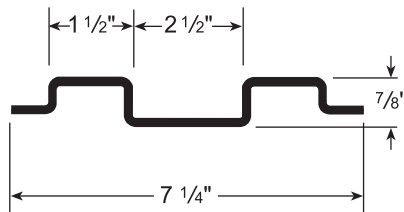

Stoughton Number
03 09686 108 75
03 09686 125 25

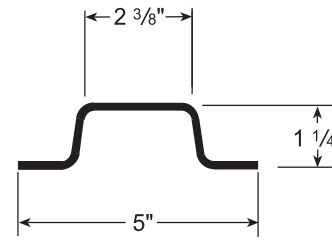

Stoughton Number
* 03 10206 108 75

Replaces 01 09902 000 00,  
03 09735 000 00 and  
03 14275 000 00

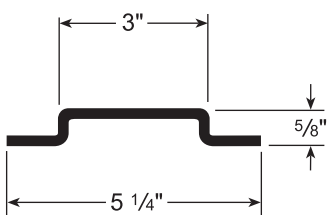

Stoughton Number
03 13509 108 75

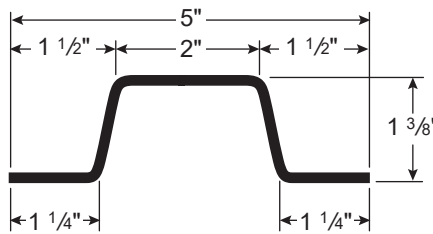

Stoughton Number	Remarks
03 16930 108 75	Unpunched
03 16930 124 75	Unpunched

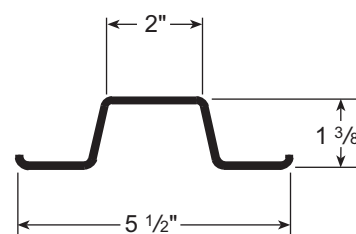

Stoughton Number	Remarks
01 06407 064 00	Punched
01 10041 006 00	
03 06347 110 00	
03 06347 124 75	

\* Refers to Container

## SIDEWALL POSTS – ROLLED STEEL

Stoughton

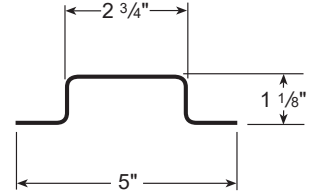
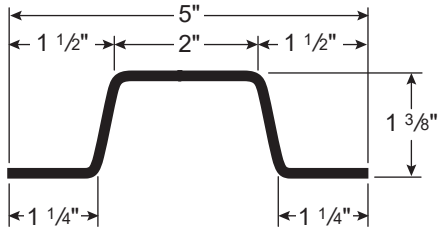
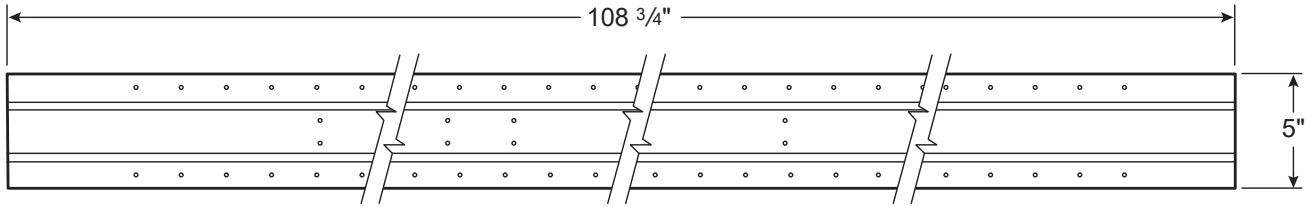

Stoughton Number	Remarks
04 18999 006 00	108 <sup>3</sup> / <sub>4</sub> " Punched

14 GA. GALVANIZED

Stoughton Number
04 19648 005 00

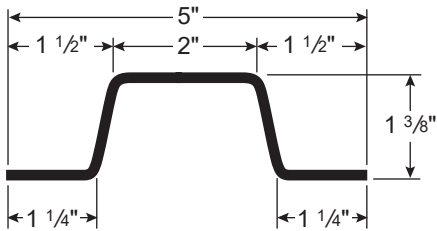
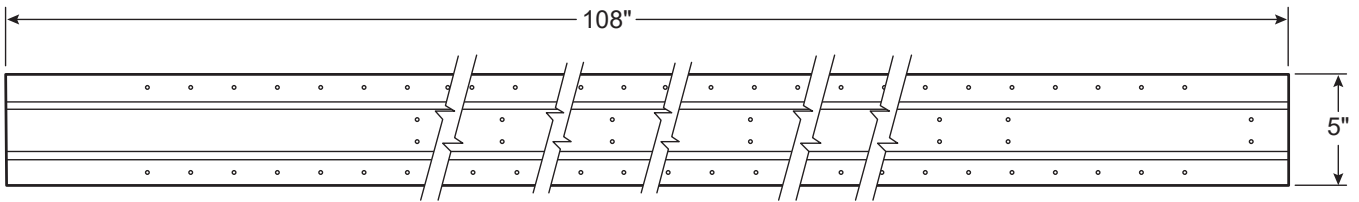

Stoughton Number	Remarks
04 23654 000 00	108" Punched

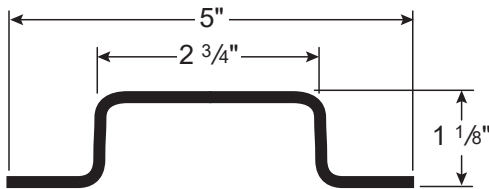
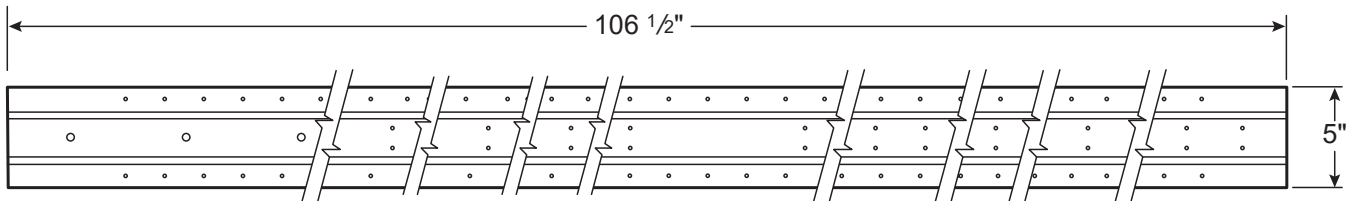

Stoughton Number	Remarks
04 21216 000 00	106 <sup>1</sup> / <sub>2</sub> " Punched

## SIDEWALL POSTS – LOGISTICS POSTS

Stoughton

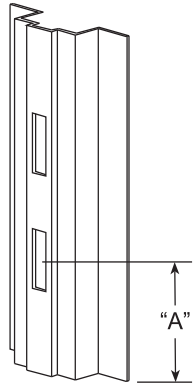

**"A" SLOT  
SINGLE TRACKED**

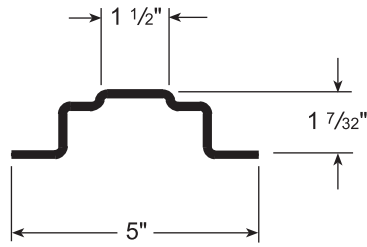

**14 GA. ROLLED STEEL**

Stoughton Number	"A"	Remarks
03 13042 108 75	7 1/8"	AVW

Replaces 03 13432 108 75

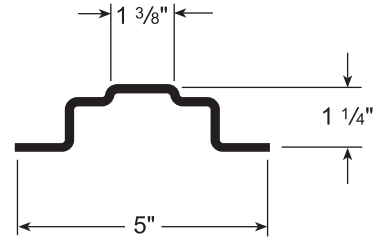

**14 GA. GALVANIZED**

Stoughton Number	"A"	Remarks
01 13080 006 00	6 1/4"	Punched, AVW
04 18998 006 00	15 1/8"	Punched, AVW

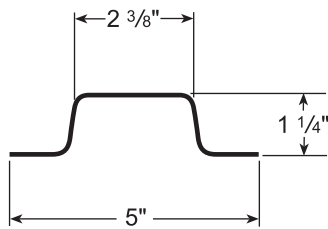

**16 GA. GALVANIZED**

Stoughton Number	"A"	Remarks
04 20098 001 00	24 1/8"	FedEx Ground
04 20098 002 00	49 1/8"	FedEx Ground

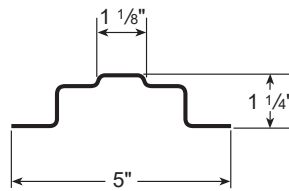

**14 GA. GALVANIZED**

Stoughton Number	"A"
04 20577 006 00	14 3/8"
04 21026 000 00	108"

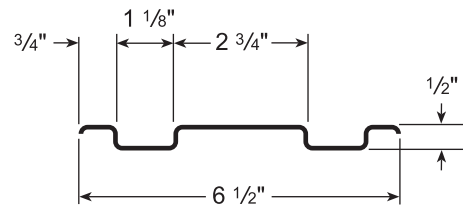

**14 GA. GALVANIZED**

Stoughton Number	"A"	Remarks
04 20671 006 00	14 3/8"	AVXW

Replaces 04 23439 006 00

Note: 21 04492 000 00 is the same part, but includes attached reinforcing plate

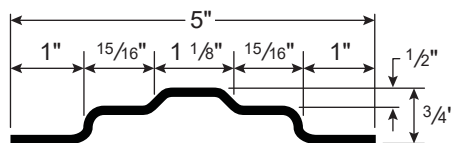
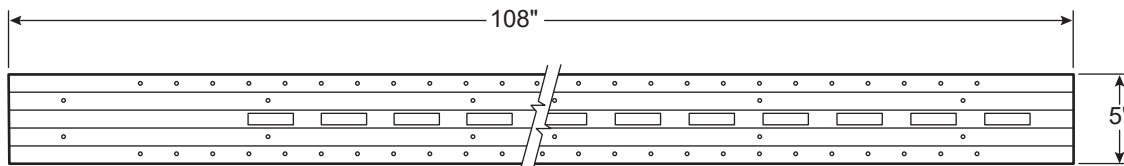

Stoughton Number
04 20679 006 00





# SIDEWALL POSTS – LOGISTICS POSTS

Stoughton

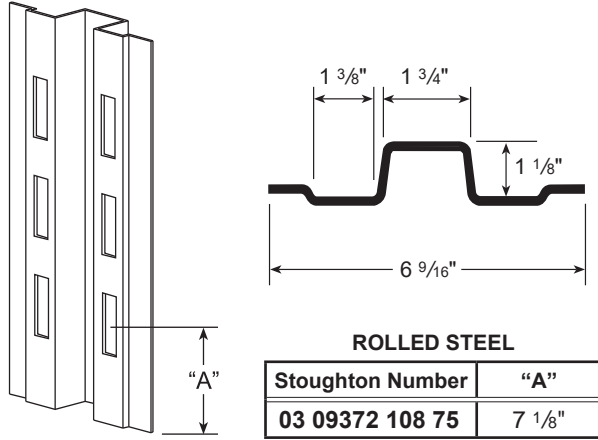

"A" SLOT  
DOUBLE TRACKED

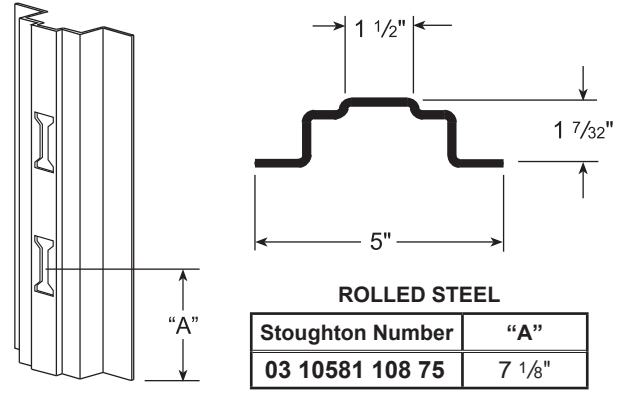

"E" SLOT  
SINGLE TRACKED

See Page 14-9 for Series "A" and Series "E" Track

# PLATE VAN SPLICE PLATES

Stoughton

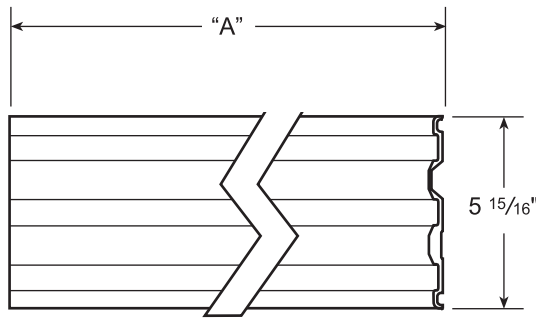
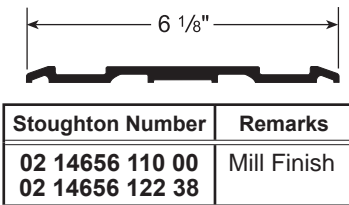
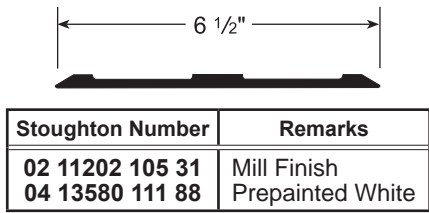

SPLICE PLATE

Stoughton Number	"A"
02 16542 110 00	110"

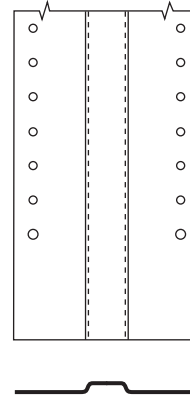

Z PLATE

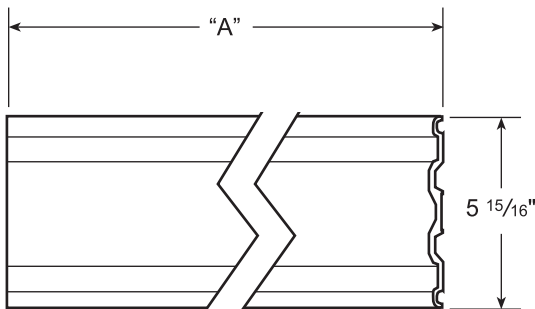

SPLICE PLATE

Stoughton Number	"A"
02 16543 106 38	106 3/8"
02 16543 122 38	122 3/8"

Stoughton Number	Length	Remarks
01 21117 006 00	109"	Outer, White
01 21117 006 01	109"	Outer, Gray
01 21117 013 00	109 3/4"	Outer, White
01 21121 006 00	109"	Inner, No Slots
01 21122 006 00	109"	Inner, 8 Slots
01 21122 013 00	109 3/4"	Inner, 8 Slots
01 23264 006 00	109"	Inner, 14 Slots

Call with VIN (Serial Number) for correct application.

## SIDEWALL POSTS

Dorsey

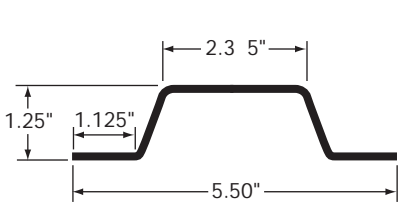

SIDE POST, 16 GA, 112" x 5"

Stoughton Number
DOR-1208829

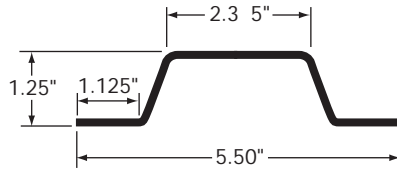

SIDE POST, 18 GA, GALV, 112"

Stoughton Number
DOR-1210513

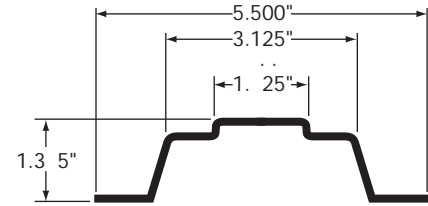

SIDE POST, STEEL

Stoughton Number
DOR-2709311

Fruehauf

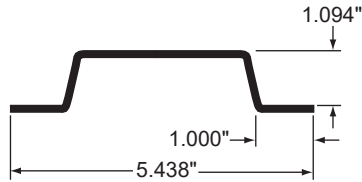

SIDE POST, ALUM, 115" L

Stoughton Number
FRU#STK020522

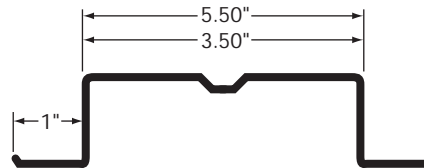

SIDE POST, STEEL, 109" L

Stoughton Number
FRU#STK30237-109

Great Dane

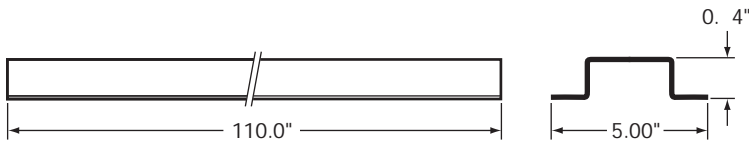

HAT SIDE POST, PUNCHED, 110"

Stoughton Number
GD#.64HATPOST

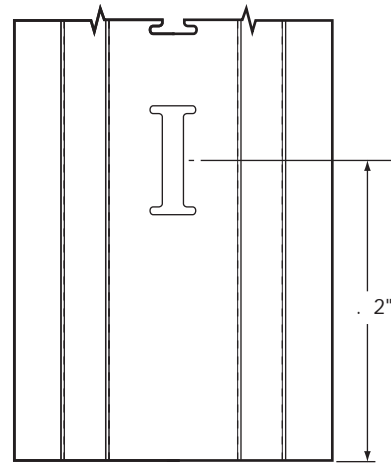

SIDE POST, LOGITIC, E-SLOT, 120.5"

Stoughton Number
GD#00400

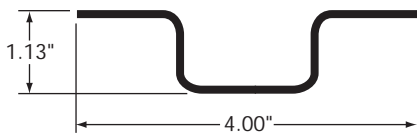

SIDE POST, UNPUNCHED, 110"

Stoughton Number
GD#00300

## SIDEWALL POSTS Great Dane

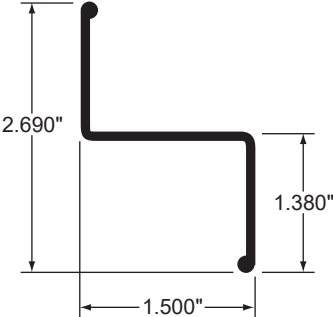

1.5" Z-POST, 110" LONG

Stoughton Number
GD#70262

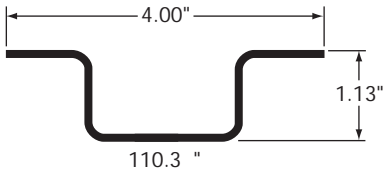

SIDE POST, PUNCHED, 110"

Stoughton Number
GD#40900411

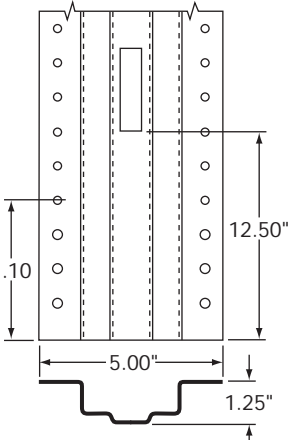

SIDE POST, A LOGISTIC, 16 GA, 109.25"

Stoughton Number
GD#40910400

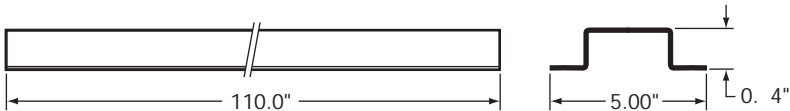

HAT SIDE POST, PUNCHED, 110"

Stoughton Number
GD#40900610

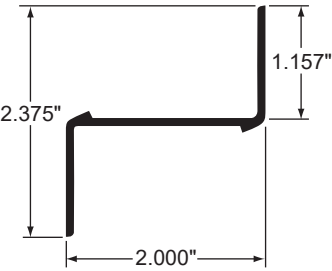

Z SIDE POST, 2" x 114" L

Stoughton Number
GD#60409004

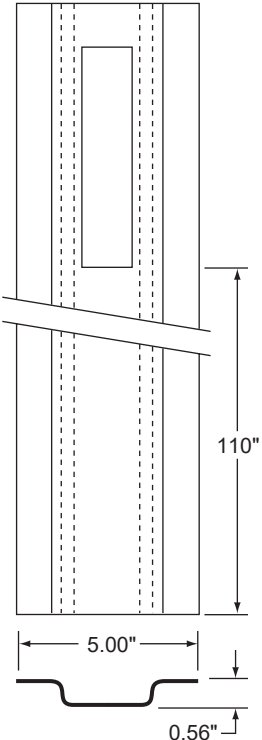

SIDE POST, 14 GA, 110"

Stoughton Number
GD#69102998

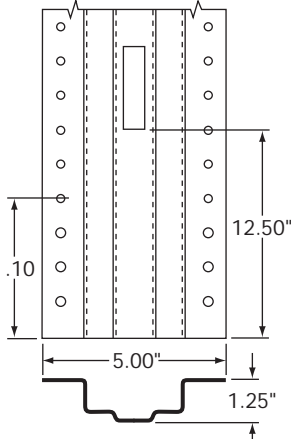

SIDE POST, A LOGISTIC, 12 GA, 106"

Stoughton Number
GD#69103003

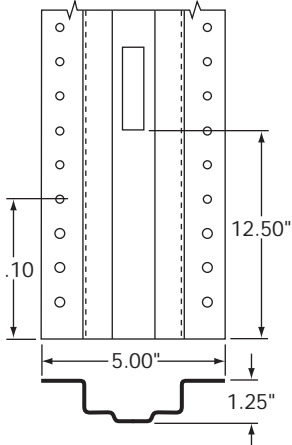

SIDE POST, LOGISTIC, 12 GA, 106"

Stoughton Number
GD#69104357

## SIDEWALL POSTS

Hyundai

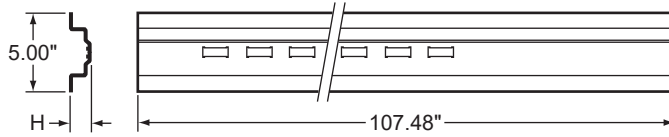

5" W SIDE POST, E-SLOT, 107.48"

Stoughton Number
HY#1000-2740

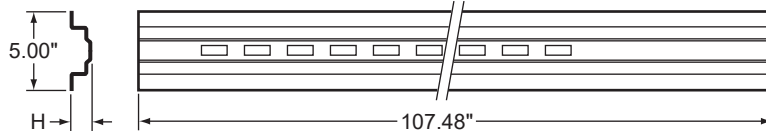

5" W SIDE POST, A-SLOT, 107.48"

Stoughton Number
HY#1000-2741



CAPPING POST

Stoughton Number
HY#1000-3453

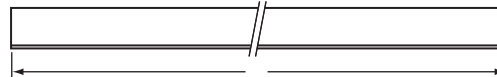

5 x 1.25" SIDE POST, ALUM, 107.5"

Stoughton Number
HY#1000-4293

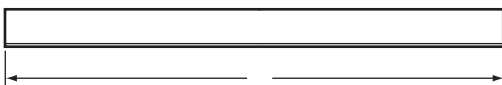

SIDE POST

Stoughton Number
HY#1000-4925

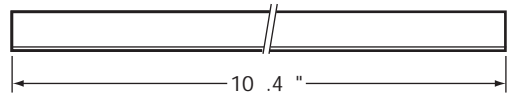

5" SIDE POST, 107.48"

Stoughton Number
HY#1000-5097

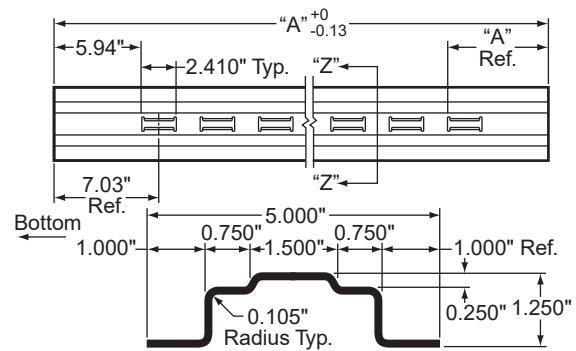
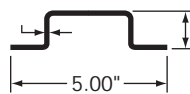

SIDE POST, LOGISTIC

Stoughton Number
HY#1000-5950

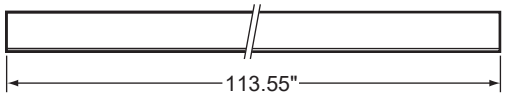

SIDE POST, 113.55", PUNCHED 2" O.C.

Stoughton Number
HY#1000-6253

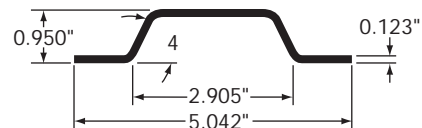
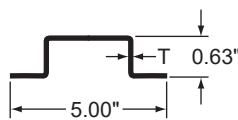

SIDE POST, 110"

Stoughton Number
HY#1000-8761

## SIDEWALL POSTS Hyundai

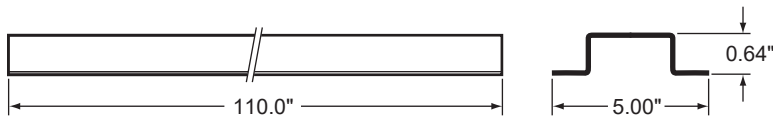

SIDE POST, GALV, A-SLOT, 110" L

Stoughton Number
HY#1001-1202

Picture  
Not  
Available

SIDE POST, A-TRACK, 113.27" L

Stoughton Number
HY#1001-3197

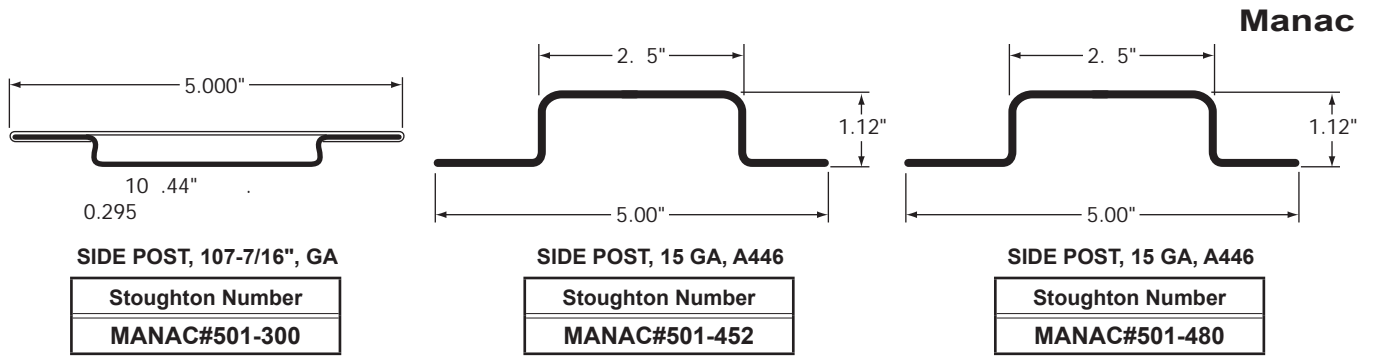

SIDE POST, 107-7/16", GA

Stoughton Number
MANAC#501-300

SIDE POST, 15 GA, A446

Stoughton Number
MANAC#501-452

SIDE POST, 15 GA, A446

Stoughton Number
MANAC#501-480

### Manac

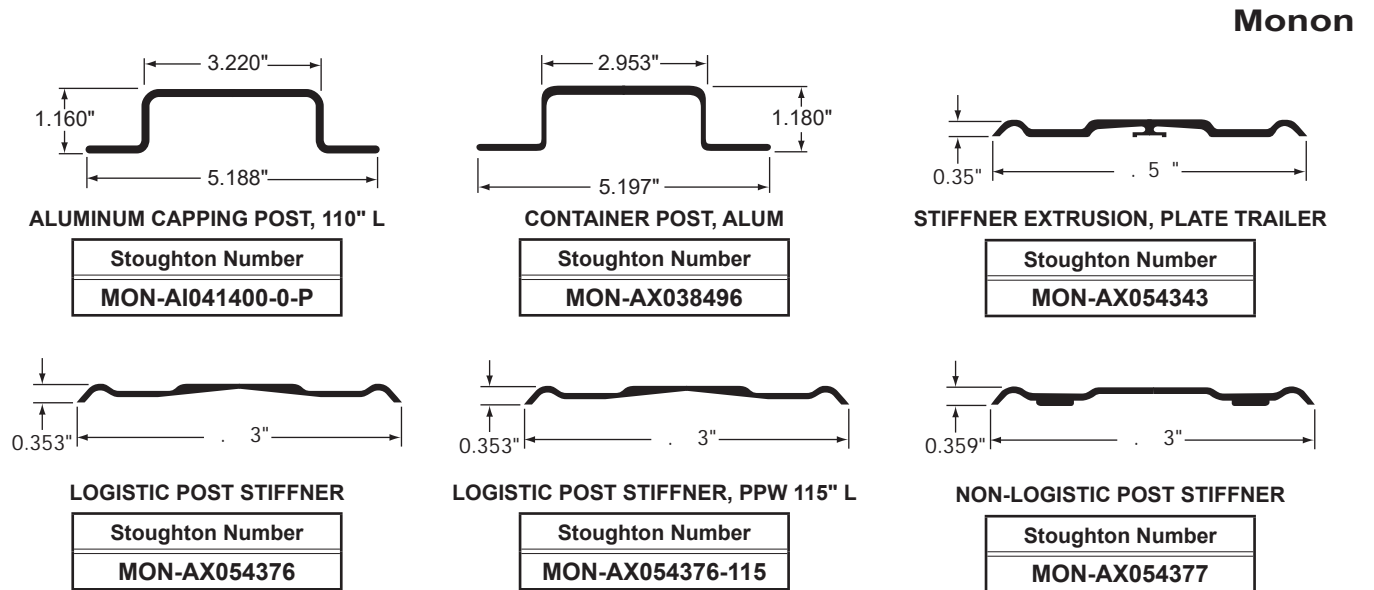

ALUMINUM CAPPING POST, 110" L

Stoughton Number
MON-AI041400-0-P

CONTAINER POST, ALUM

Stoughton Number
MON-AX038496

STIFFNER EXTRUSION, PLATE TRAILER

Stoughton Number
MON-AX054343

LOGISTIC POST STIFFNER

Stoughton Number
MON-AX054376

LOGISTIC POST STIFFNER, PPW 115" L

Stoughton Number
MON-AX054376-115

NON-LOGISTIC POST STIFFNER

Stoughton Number
MON-AX054377

### Monon

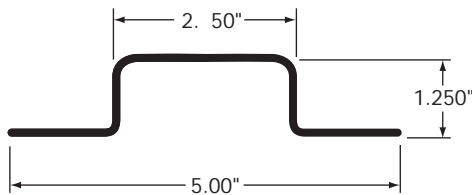

SIDE POST, HAT, 16 GA, GRD 60, 116"

Stoughton Number
MON-V02-102F

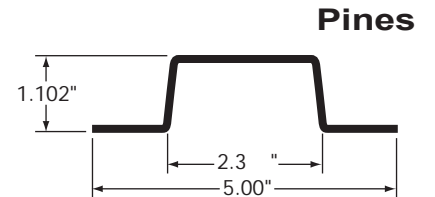

SIDE POST, PUNCHED, 16 GA, 108" x 5"

Stoughton Number
PINE SPB0847

### Pines

## SIDEWALL POSTS

### Strick

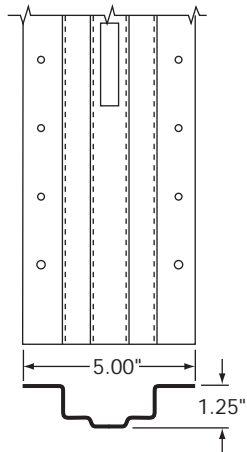

**SIDE POST, LOGISTIC, 108.75"**

Stoughton Number
<b>STR#24803</b>

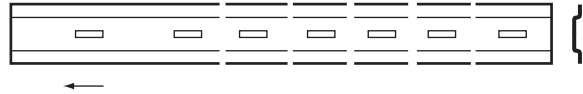

**SIDE POST, 109.25"**

Stoughton Number
<b>STR#18977</b>

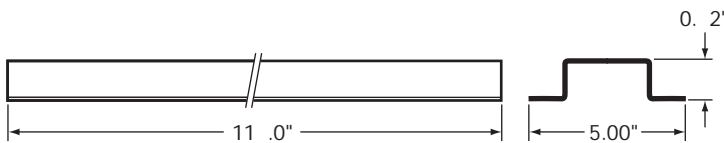

**HAT SIDE POST, PUNCHED, 116"**

Stoughton Number
<b>STR#30117</b>

**Picture  
Not  
Available**

**SIDE POST, HAT, 16 GA, GR60 109.25"**

Stoughton Number
<b>STR#SK06625</b>

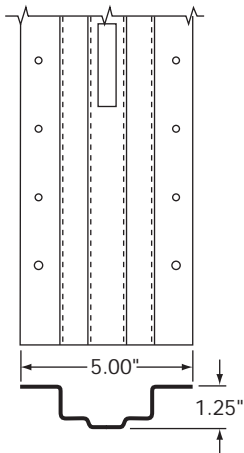

**SIDE POST, LOGISTIC, 108.75"**

Stoughton Number
<b>STR#52003</b>

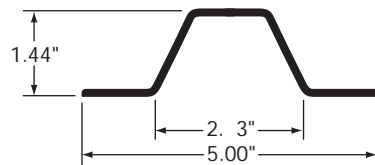

**SIDE POST, MILL, ALUM 110-13/16"**

Stoughton Number
<b>STRAA63C0017200</b>

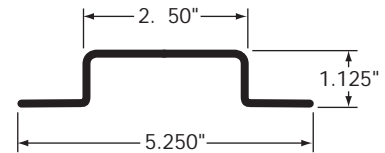

**SIDE POST, PUNCHED, 110"**

Stoughton Number
<b>STRAA63C06444500</b>

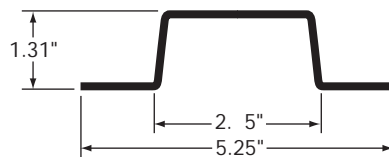

**SIDE POST, 12 GA, 107.5" x 5.25"**

Stoughton Number
<b>STRAA63C07421900</b>

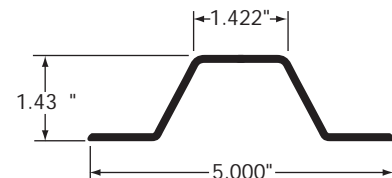

**SIDE POST, 110"-120" L**

Stoughton Number
<b>STRAS92C-0015-09</b>

## SIDEWALL POSTS Trailmobile

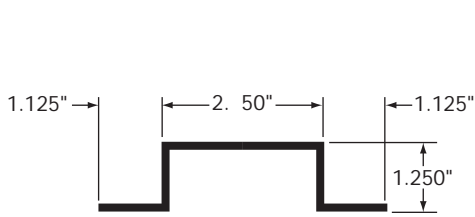

**SIDE POST, ALUM, 114" L**

Stoughton Number
TM90-4-483-0-114

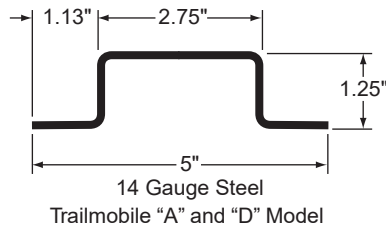

**5" SIDE POST, 14 GA STEEL, 123"**

Stoughton Number
TM90-4-983-0-123

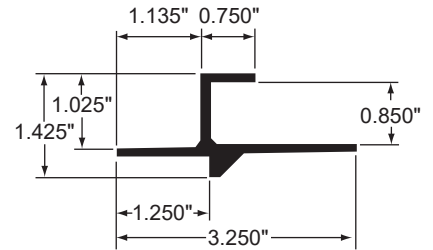

**SIDE POST, ALUM, 108" L**

Stoughton Number
TM90-4-1081-0108

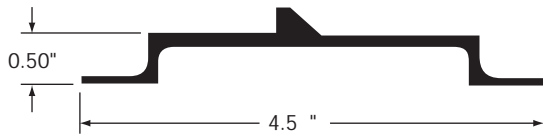

**SIDE POST, 110" L**

Stoughton Number
TM90-4-1721-0110

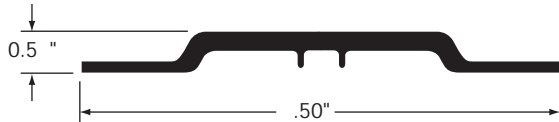

**SIDE POST, 123" L**

Stoughton Number
TM90-4-1911-0123

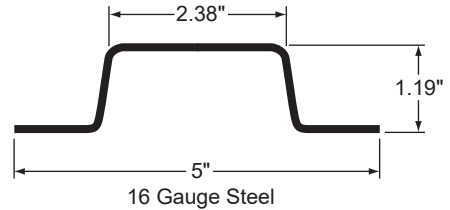

**5" SIDE POST, UNPUNCHED , 16 GA, 112"**

Stoughton Number
TM90-4-1988-0112
TM90-4-1988P0112

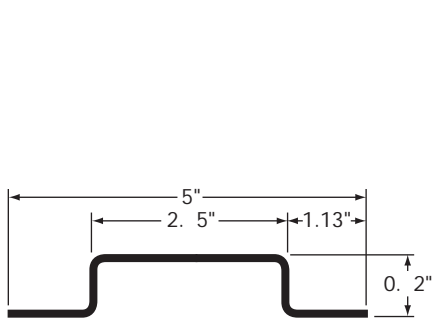

**SIDE POST, GALV, PUNCHED, 112"**

Stoughton Number
TM90-4-2033P0112

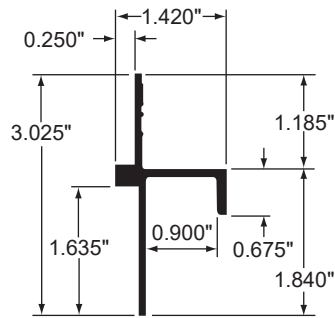

**SIDE POST, ALUM, 121" L**

Stoughton Number
TM90-4-2349-0121

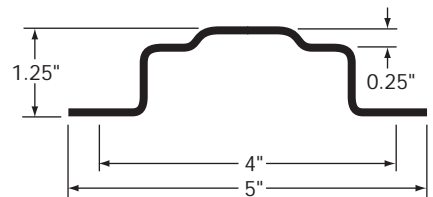

**SIDE POST, 16 GA, GALV 107.44"**

Stoughton Number
TM7513-5-37-1166

## SIDEWALL POSTS

### Trailmobile

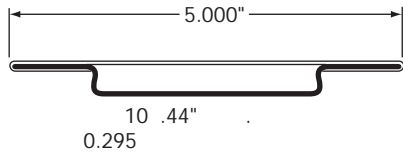

**SIDE POST, GALV 107.44"**

Stoughton Number
TM7513-5-44-1166

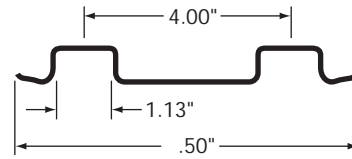

**SIDE POST, A-SLOT, 14 GA 107.63**

Stoughton Number
TM6513-5-130-12

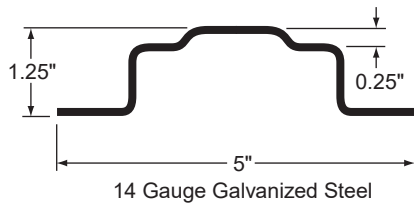

**SIDE POST, E-SLOT, 14 GA 106.875"**

Stoughton Number
TM513-5-600-1166

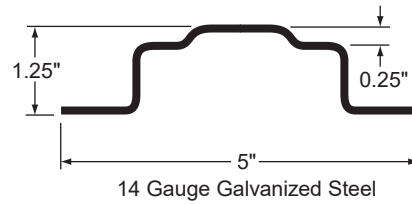

**SIDE POST, A-SLOT, 14 GA, 115.25"**

Stoughton Number
TM513-5-600-1250

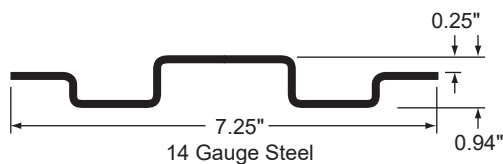

**SIDE POST, LOG A-SLOT, 106-5/8"**

Stoughton Number
TM9513-5-1114

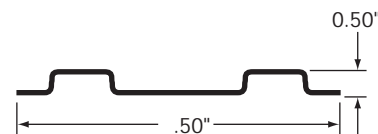

**SIDE POST, A-SLOT, 12 GA, GALV 112"**

Stoughton Number
TM513-686-1226-A



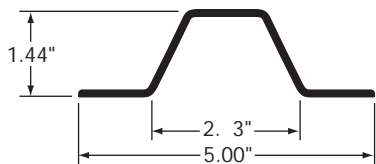

**SIDE POST, ALUM, J POST 110"**

Stoughton Number
UT-01-6500-110

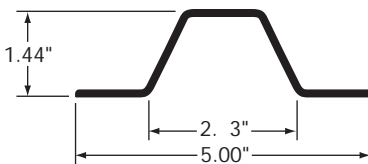

**SIDE POST, ALUM, J POST 115"**

Stoughton Number
UT-01-6500-157

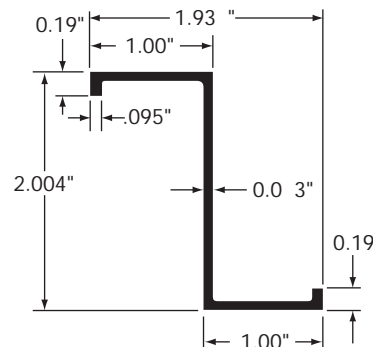

**Z POST, 114.5" L**

Stoughton Number
UT-01-6500-0-14

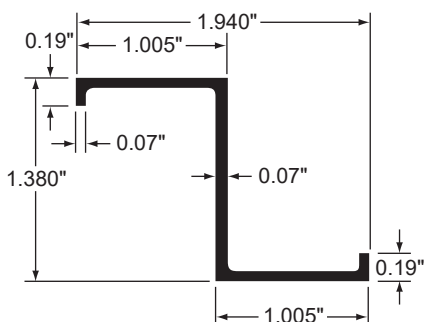

**Z POST, 114.5" L**

Stoughton Number
UT-01-6500-0-35

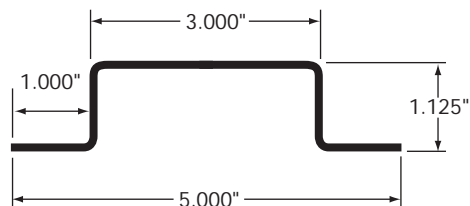

**SIDE POST, PUNCHED, STEEL, 110" L**

Stoughton Number
UT-118

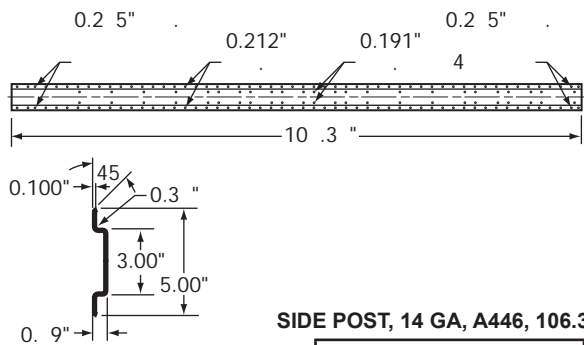

**SIDE POST, 14 GA, A446, 106.375"**

Stoughton Number
UT-03-6512-0-027

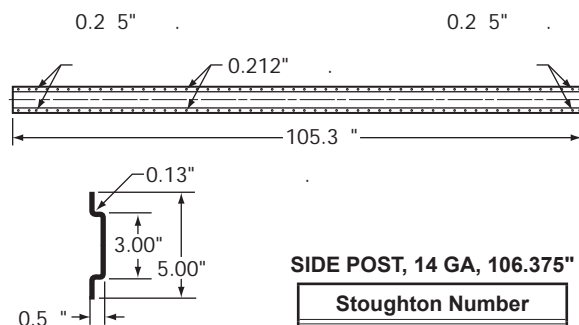

**SIDE POST, 14 GA, 106.375"**

Stoughton Number
UT-03-6512-0-028

## SIDEWALL POSTS

### Utility

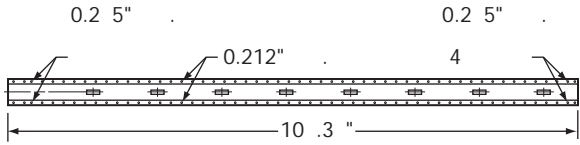

**SIDE POST, 14 GA, 106.375"**

Stoughton Number
UT-03-6512-0-029

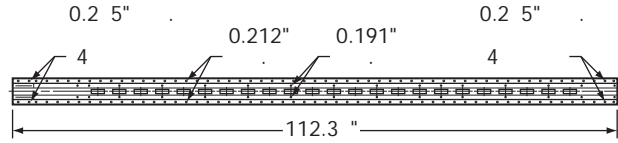

**POST, LOGISTIC, 112.375"**

Stoughton Number
UT-03-6512-0-033

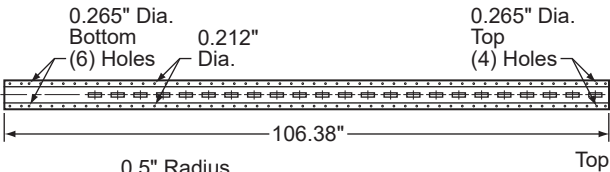

**SIDE POST, 14 GA, 106.375"**

Stoughton Number
UT-03-6512-0-040

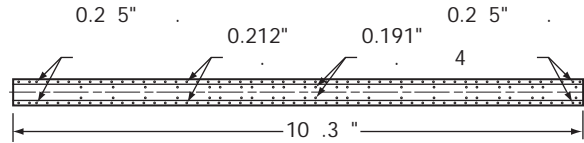

**SIDE POST, 16 GA, 106.375"**

Stoughton Number
UT-03-6513-0-019

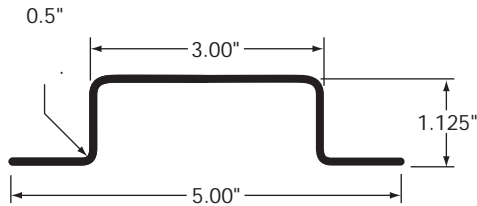
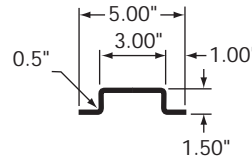
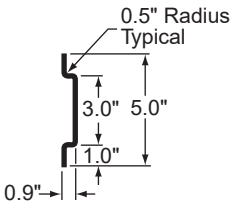

**SIDE POST, 16 GA, 110.188"**

Stoughton Number
UT-03-6513-0-033

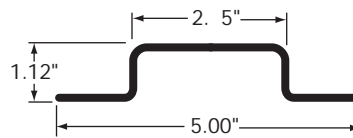

**SIDE POST, 14 GA, 108.75"**

Stoughton Number
UT-03-6512-0-026

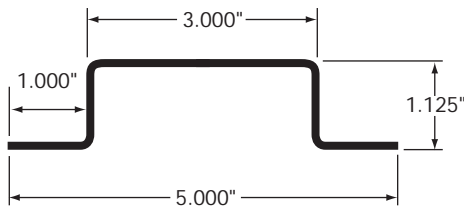

**SIDE POST, PUNCHED, STEEL, 110" L**

Stoughton Number
UT-03-6513-0-011

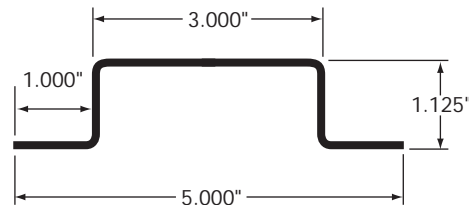

**SIDE POST, PUNCHED, STEEL, 110" L**

Stoughton Number
UT-03-6513-0-016

## SIDEWALL POSTS

Wabash

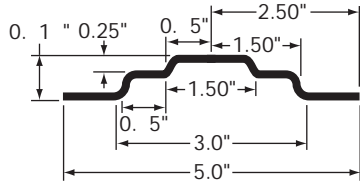

**LO-PRO POST, LOGISTIC, 107.62"**

Stoughton Number
WAB-00120144

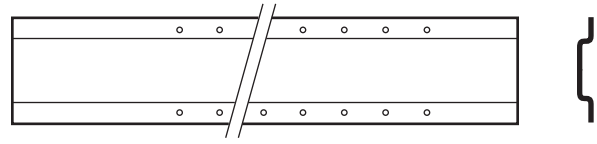

**SIDE POST, 16 GA, GALV STEEL**

Stoughton Number
WAB-01200038

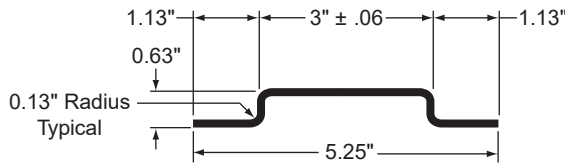

**SIDE POST, 16 GA, GALV STEEL**

Stoughton Number
WAB-01200047

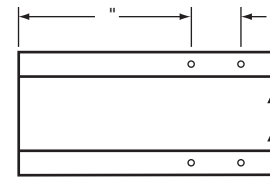

**5" SIDE POST, 16 GA, GALV, 112"**

Stoughton Number
WAB-01200069

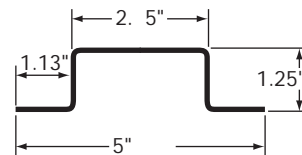

**SIDE POST, A-SLOT, STEEL, 128"**

Stoughton Number
WAB-01200109

## SIDEWALL POSTS

Wabash

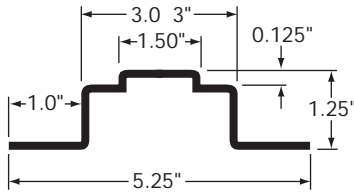

SIDE POST, LOGISTIC, 106-1/4"

Stoughton Number
WAB-01200120

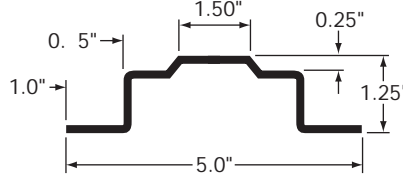

SIDE POST, LOGISTIC, 132-1/2"

Stoughton Number
WAB-01200202

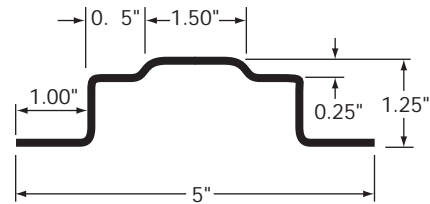

SIDE POST 16 GA, GALV STEEL, 125"

Stoughton Number
WAB-01200262

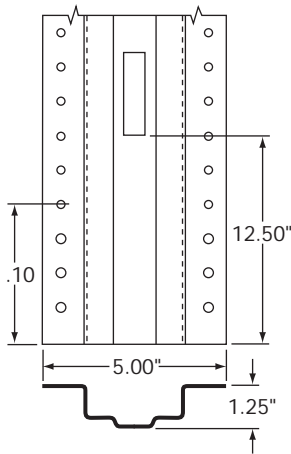

SIDE POST, LOGISTIC, STEEL, 111-7/8"

Stoughton Number
WAB-01200464

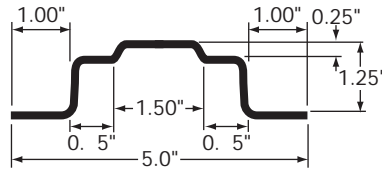

E POST, LOGISTIC, 107.375"

Stoughton Number
WAB-01200550

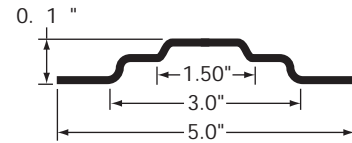

LO-PRO POST, LOGISTIC, STEEL, 109.62"

Stoughton Number
WAB-01200725

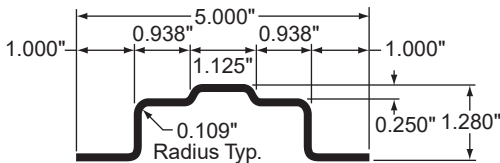

5" SIDE POST, LOG, A-SLOT, 107.875"

Stoughton Number
WAB-01200923

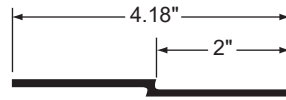

STARTER POST, ALUM, 120"

Stoughton Number
WAB-E0901200

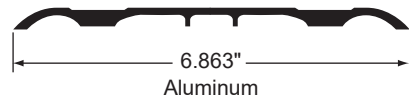

OUTER POST, PUNCHED, 120"

Stoughton Number
WAB-E3501200

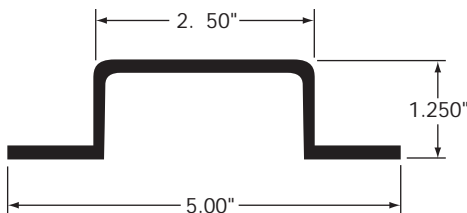

SIDE POST, ALUM 114" L

Stoughton Number
WAB-E468114



7" SIDE POST, PUNCHED, ALUM, 126"

Stoughton Number
WAB-E8411260

## NOSE PANELS Stoughton

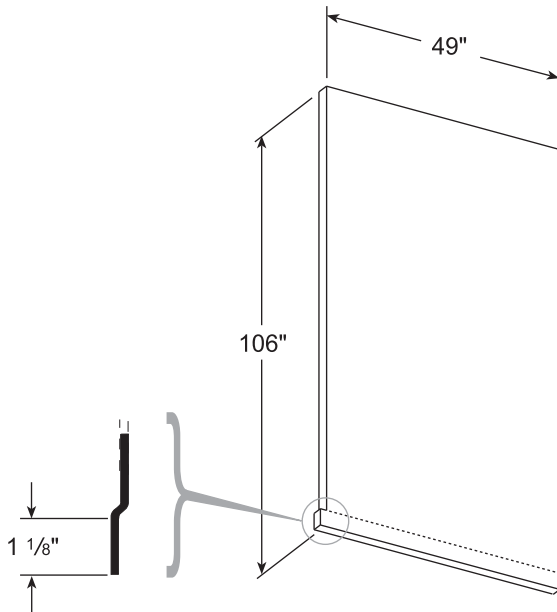

NOSE PANEL UNPUNCHED - OFFSET

Stoughton Number	Remarks
01 14719 XXX 01	.050 Aluminum – Prepainted White
01 14703 X06 09	UPS Gray

For flat sheets commonly used on front walls, see Sidewall Panels on page 2-35

## SIDEWALL PANELS Stoughton

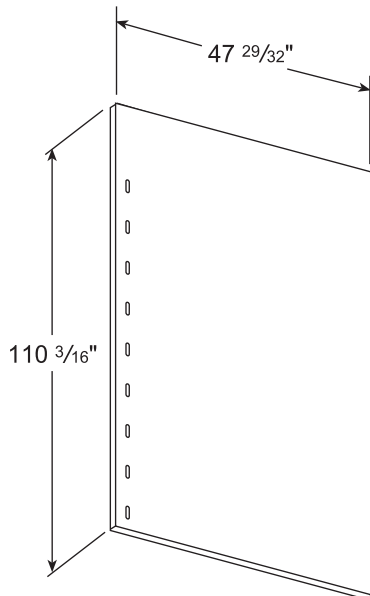

LOGISTIC PLATE SIDEWALL PANEL

Stoughton Number	Remarks
01 17051 1XX XX	.144 Aluminum – Prepainted White – Roadside
01 17051 2XX XX	.144 Aluminum – Prepainted White – Curbside
01 16658 XX9 10	.144 Mill Finish Slotted Plate Panel*

\* Specify roadside or curbside when ordering

# SIDEWALL PANELS

Stoughton

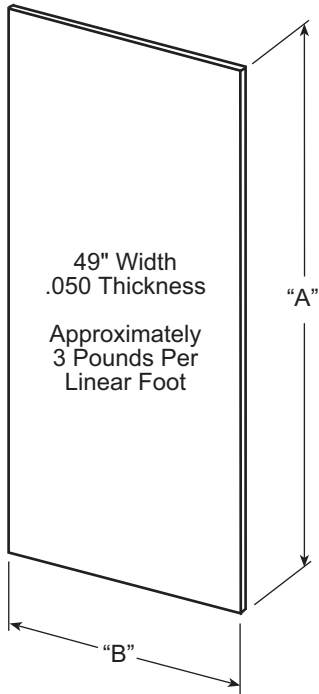

### FLAT SIDEWALL PANEL UNPUNCHED

Stoughton Number	"A"	"B"	Thickness	Remarks
01 09033 XX1 00	110"	49"	.026	Prepainted White Galavan
01 09904 XX1 01	110"	49"	.050	Prepainted White Alum.
01 09904 XX2 01	120"	49"	.050	Prepainted White Alum.
01 09904 XX2 07	120"	49"	.050	Prepainted Black
01 09904 XXX 07	110"	49"	.050	Prepainted Black
01 09904 XXX 15	110"	49"	.050	Prepainted UPS Gray
01 09904 110 PV	110"	49"	.050	PVC Coated White
01 13214 XXX 04	103.5"	49"	.050	Brookville Silver (other colors avail.)

### FLAT SIDEWALL PANEL – PLATE VAN – UNPUNCHED

Stoughton Number	"A"	"B"	Thickness	Remarks
04 16654 001 01	112"	49"	.144	Mill Finish
04 16654 126 00	126"	49"	.144	Prepainted White

### MIRROR STAINLESS PANELS

Stoughton Number	"A"	"B"	Thickness	Remarks
00 14000 144 49	144"	49"	.036	Side Panel
00 14036 120 36	120"	36"	.036	Nose Panel

### Z PANEL

Stoughton Number	"A"	"B"	Thickness	Remarks
01 22503 XX6 00	109"	47 3/8"	.255	Z "G" Panel – White
01 22503 XX6 02	109"	47 3/8"	.255	Z "G" Panel – Fleet Gray

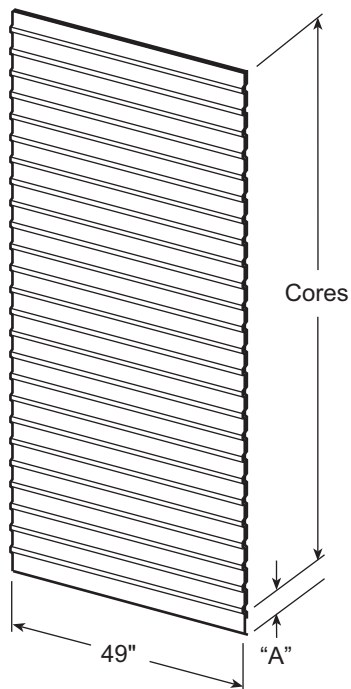

Corrugations (75% of Actual Size)

### CORRUGATED SIDEWALL PANEL UNPUNCHED

Stoughton Number	Cores	Width	Thickness	Remarks	"A"
01 08561 110 01	23	49"	.050	Prepainted White Alum.	3 1/2"
01 08561 105 01	24	49"	.050	Prepainted White Alum.	3 1/2"
01 08215 XXX 00	25	49"	.050	Prepainted White Alum.	3 1/2"
01 13757 X04 00	23	49"	.050	Prepainted White Alum.	4 1/2"
01 13757 X06 00	24	49"	.050	Prepainted White Alum.	4 1/2"
01 13757 X11 00	25	49"	.050	Prepainted White Alum.	4 1/2"

"A" – Bottom of panel to center of first core

Call with trailer VIN (Serial Number) for correct application

## SIDEWALL PANELS Dorsey

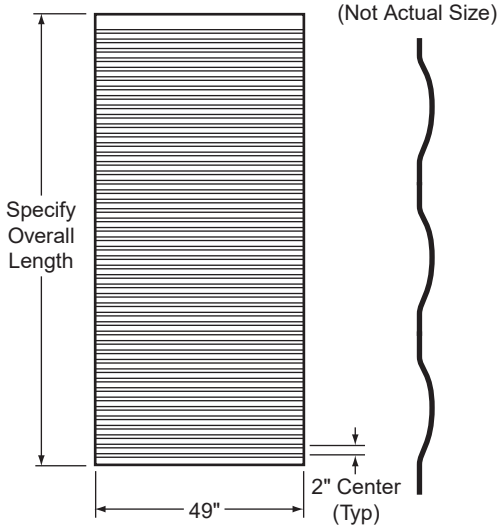

SIDE PANEL, CORR, WHT, ALUM

Stoughton Number
DOR-SD-36-919-13

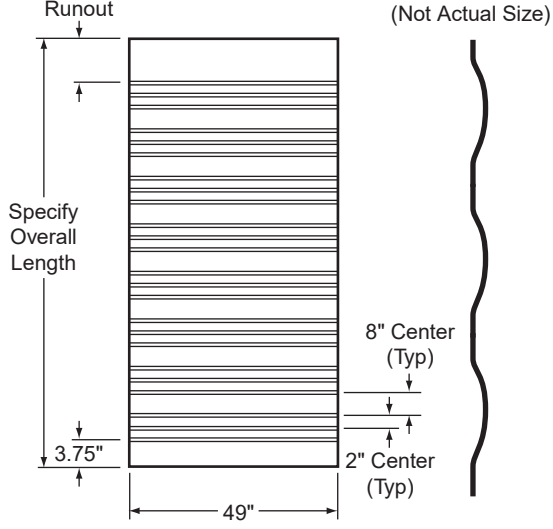

SIDE PANEL, CORR, MILL, 24 CORR

Stoughton Number
DOR-SD-38-503-24

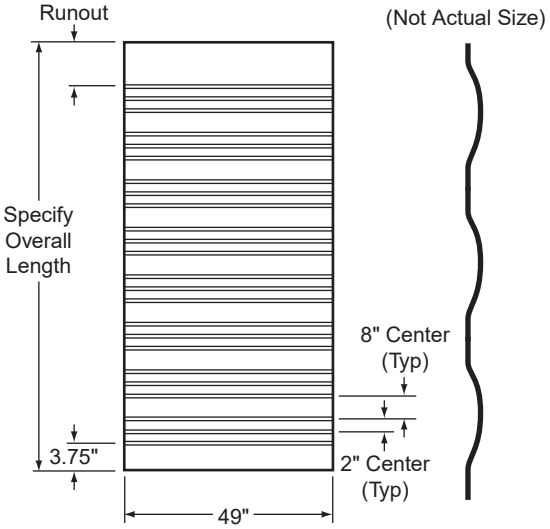

SIDE PANEL, CORR, GRAY, 24 CORR

Stoughton Number
DOR-SG-38-503-24

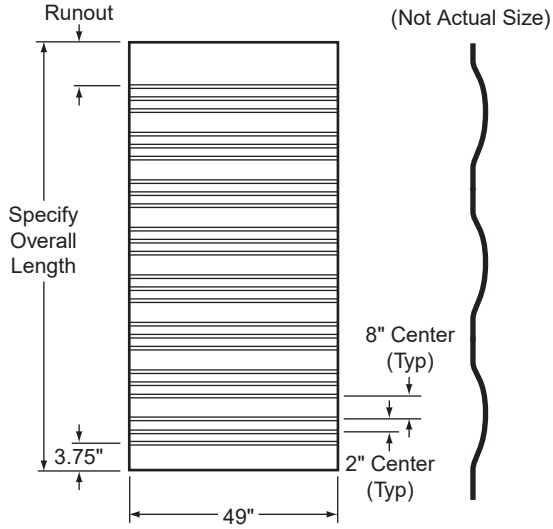

SIDE PANEL, CORR, WHT, 24 CORR

Stoughton Number
DOR-SW-38-503-24

"Dorsey," "Fruehauf," "Great Dane," "Hyundai," "Kentucky," "Lufkin," "Monon," "Manac," "Pines," "Strick," "Trailmobile," "Utility," "Vanguard Trailer," and "Wabash" are trademarks of their respective owners and are used only to identify corresponding part numbers of Stoughton Part Sales, LLC. Stoughton Part Sales, LLC is not affiliated with the owners of these trademarks.

## SIDEWALL PANELS

### Fruehauf

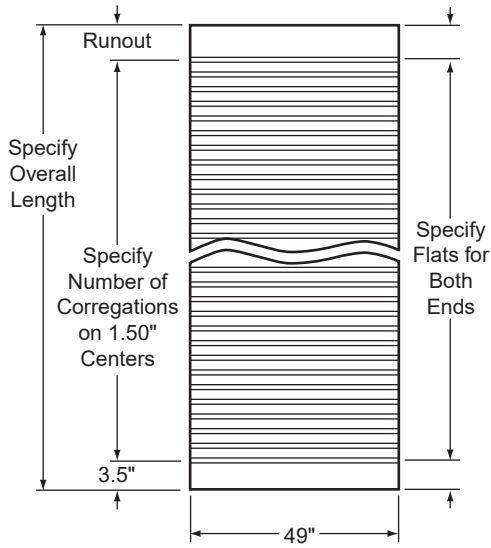

SIDE PANEL, CORR, WHT, 66"

Stoughton Number
FRU#WCC8010-2FW

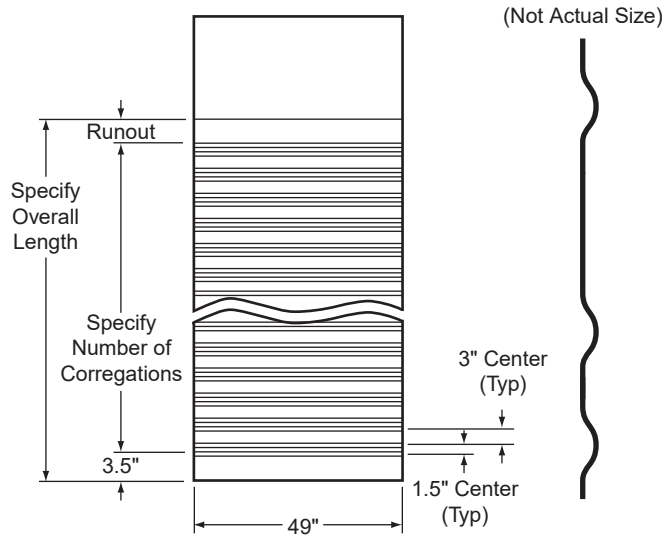

SIDE PANEL, REEFER, CORR, ENDURO

Stoughton Number
FRU#WCF5519

### Great Dane

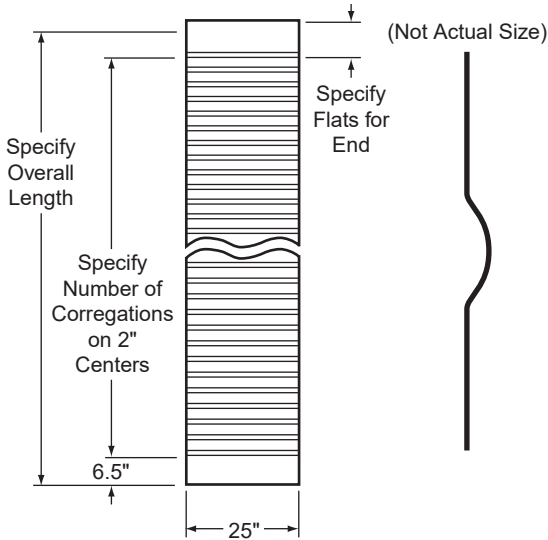

SIDE PANEL, CORR

Stoughton Number
GD#11297
GD#11298
GD#11299

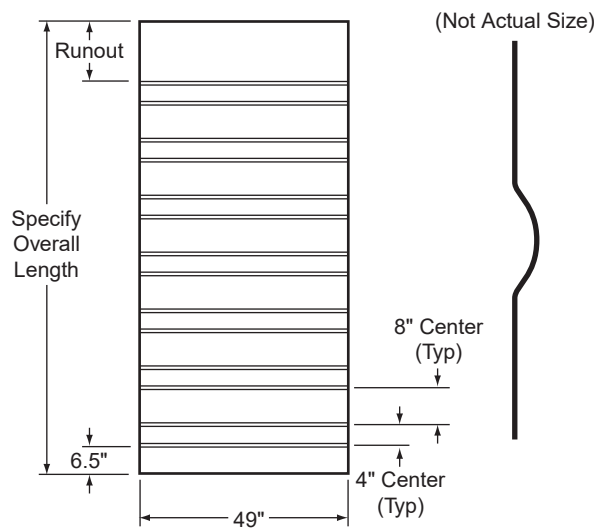

SIDE PANEL, CORR, WHT, ALUM

Stoughton Number
GD#11300



## SIDEWALL PANELS Great Dane

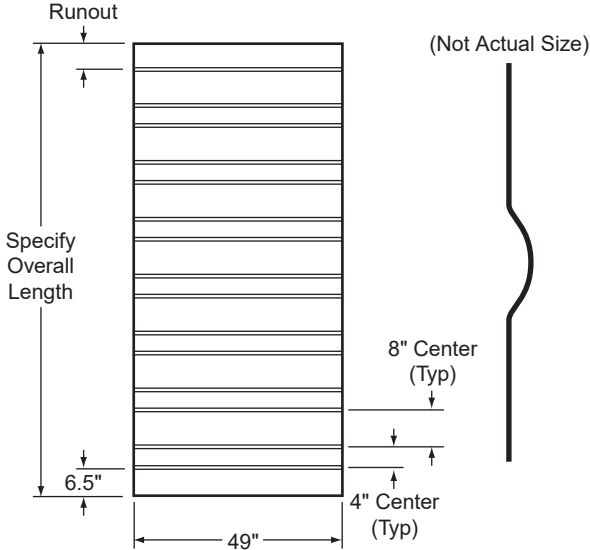

SIDE PANEL, CORR, WHT, ALUM

Stoughton Number
GD#11301

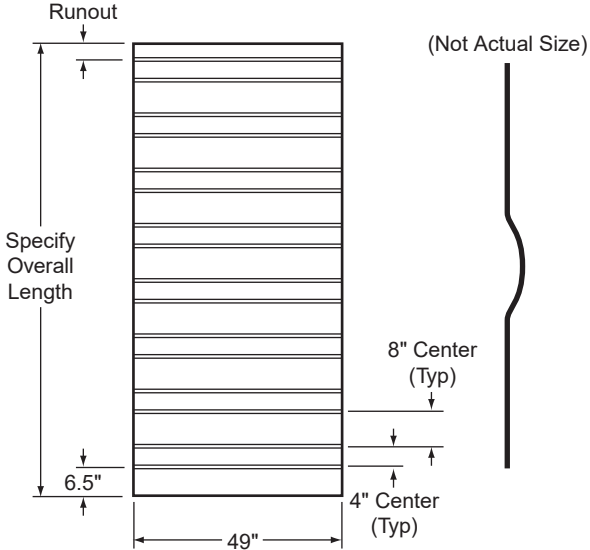

SIDE PANEL, CORR, WHT, ALUM

Stoughton Number
GD#11302

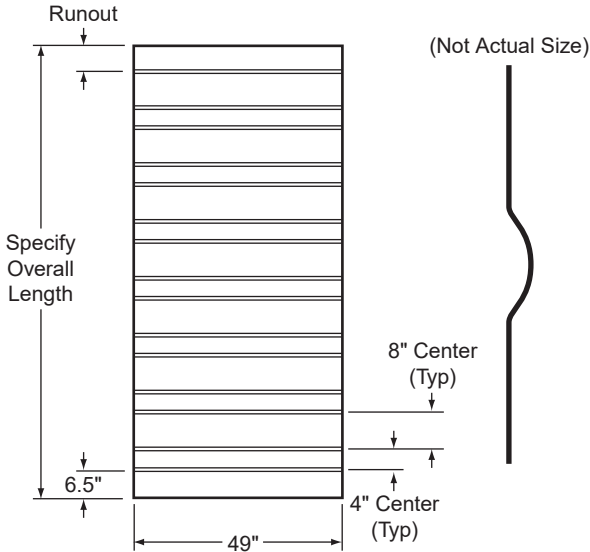

SIDE PANEL, CORR, WHT, ALUM

Stoughton Number
GD#11304

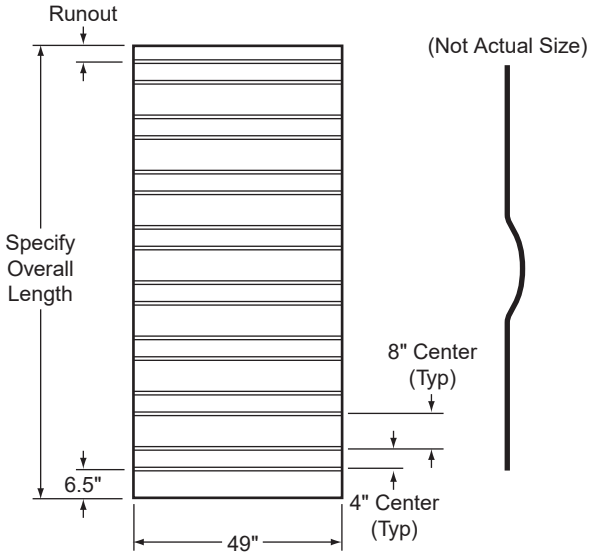

SIDE PANEL, CORR, WHT, ALUM

Stoughton Number
GD#11305

## SIDEWALL PANELS

Great Dane

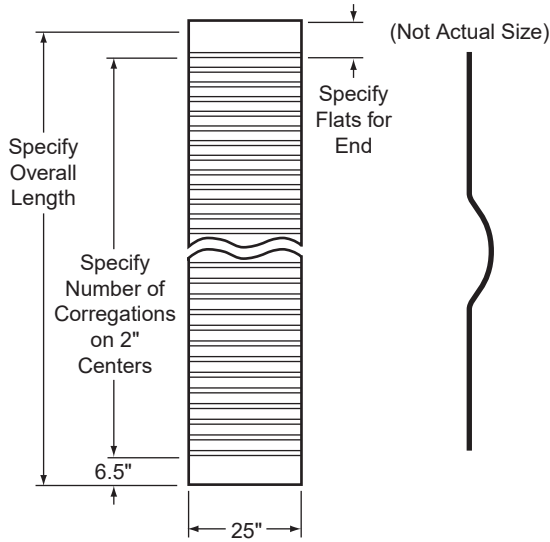

**SIDE PANEL, CORR**

Stoughton Number
<b>GD#11312</b>
<b>GD#11313</b>

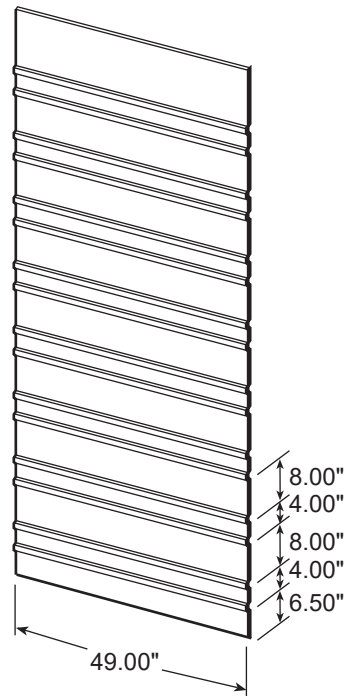

**SUPER SEAL SIDE PANEL, 16 CORR**

Stoughton Number
<b>GD#0832768701788</b>

## Manac

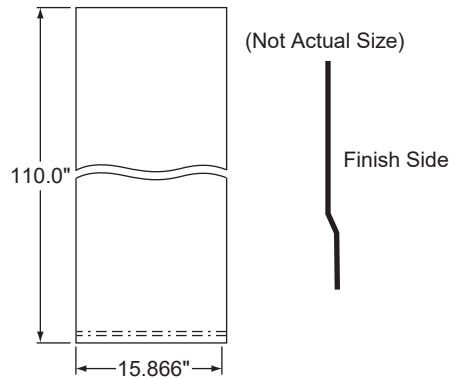

**SIDE PANEL, WHITE, 49" x 110"**

Stoughton Number
<b>MANAC#579-067</b>

## SIDEWALL PANELS Trailmobile

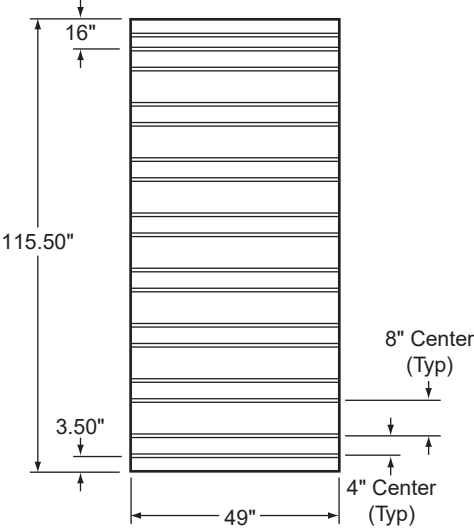

SIDE PANEL, CORR, WHT, ALUM

Stoughton Number
TM700-513-18-26

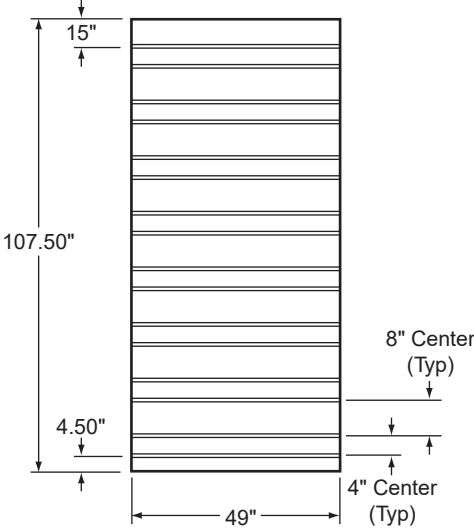

SIDE PANEL, CORR, WHT, ALUM

Stoughton Number
TM700-513-27-26

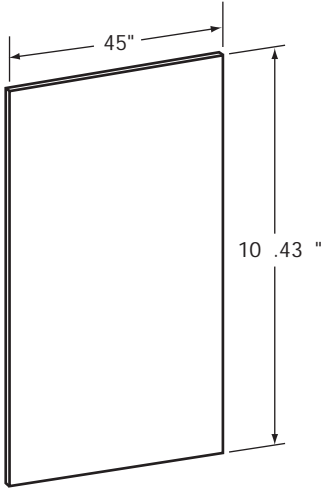

SIDE PANEL,  
45" x 107.44" x 0.236"

Stoughton Number
TM700-513-38

## Utility

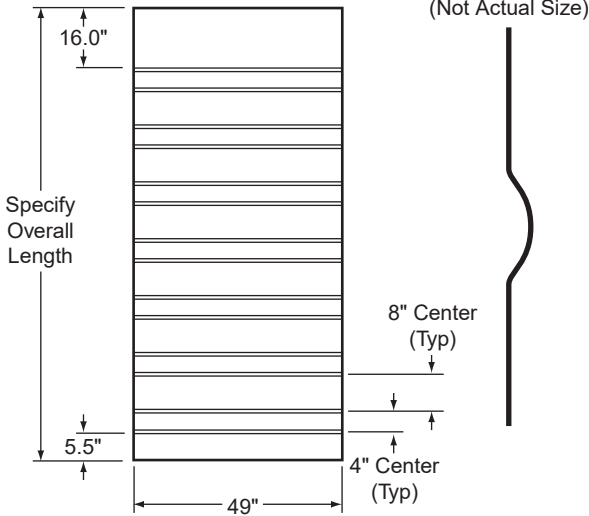

SIDE PANEL W/PVC, CORR, PPW

Stoughton Number
UT-03-6001-0-103

"Dorsey," "Fruehauf," "Great Dane," "Hyundai," "Kentucky," "Lufkin," "Monon," "Manac," "Pines," "Strick," "Trailmobile," "Utility," "Vanguard Trailer," and "Wabash" are trademarks of their respective owners and are used only to identify corresponding part numbers of Stoughton Part Sales, LLC. Stoughton Part Sales, LLC is not affiliated with the owners of these trademarks.

## SIDEWALL PANELS

### Utility

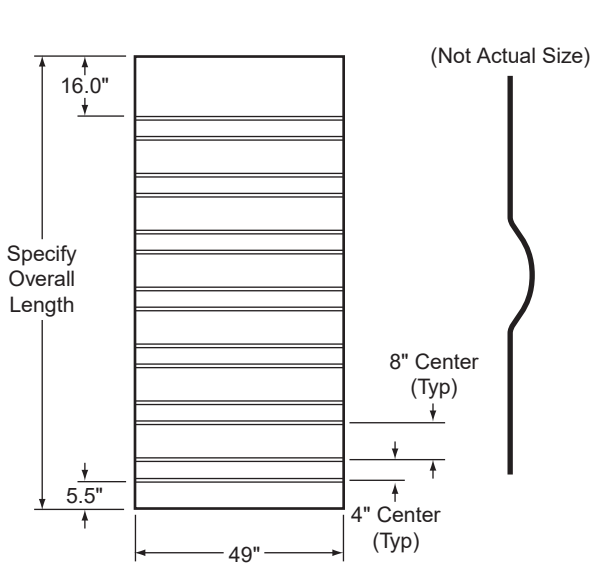

SIDE PANEL, CORR, PPW

Stoughton Number
UT-03-6001-0-104

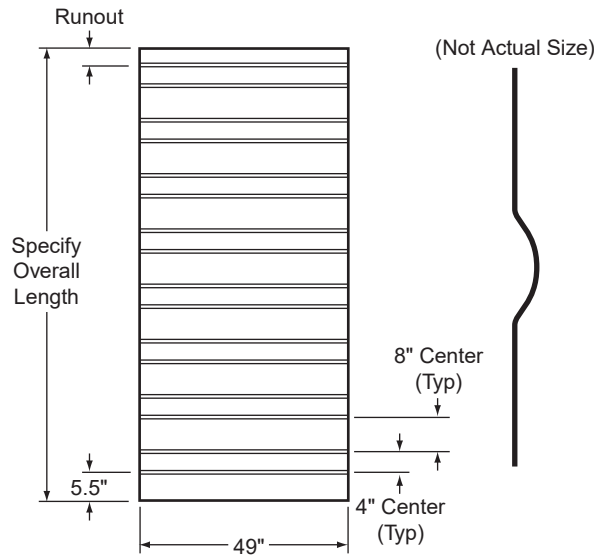

SIDE PANEL, CORR, WHT, ALUM

Stoughton Number
UT-03-6001-0-105

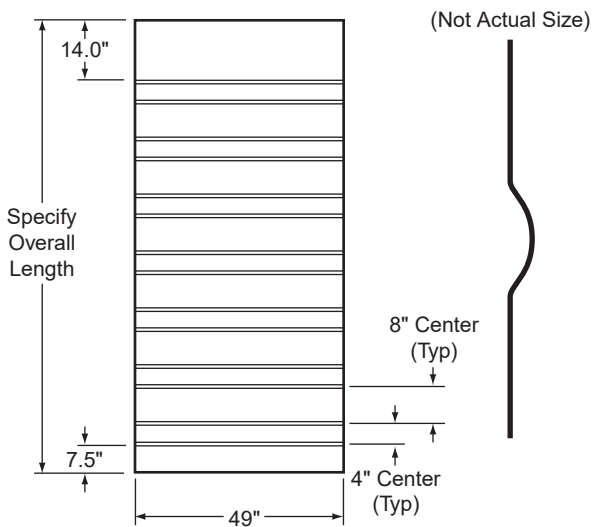

SIDE PANEL W/PVC, CORR, POLAR WHT

Stoughton Number
UT-03-6001-0-183

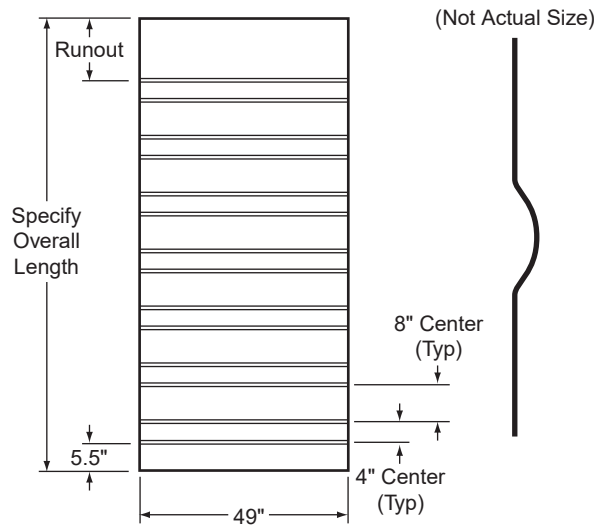

SIDE PANEL, CORR, WHT, ALUM

Stoughton Number
UT-03-6001-0-098

## SIDEWALL PANELS Wabash

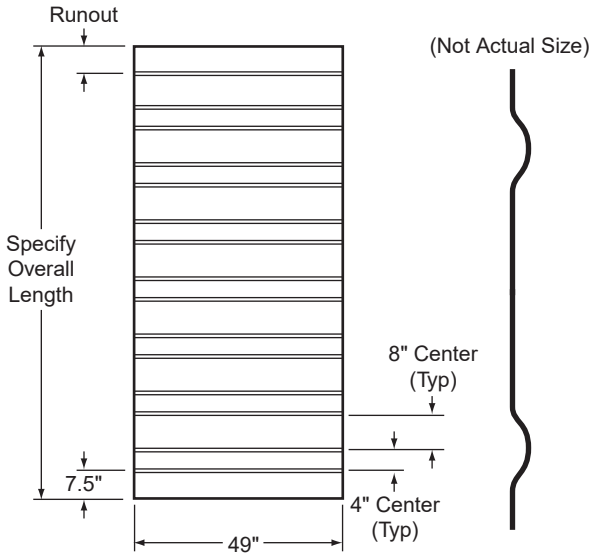

**SIDE PANEL, CORR, WHT, ALUM**

Stoughton Number
<b>WAB-01 C 00059</b>

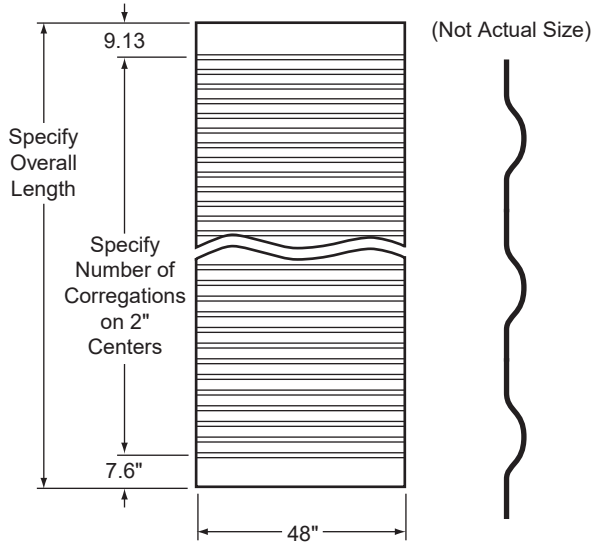

**SIDE PANEL, CORR, SS**

Stoughton Number
<b>WAB-01 C00062</b>

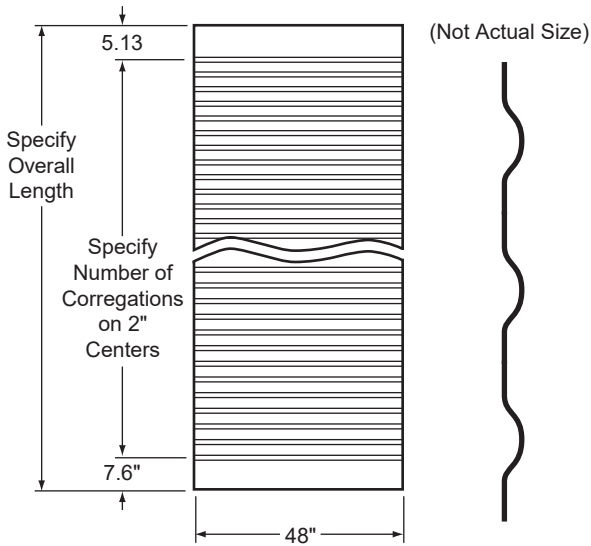

**SIDE PANEL, CORR, SS, 100.625"**

Stoughton Number
<b>WAB-01 C00205</b>

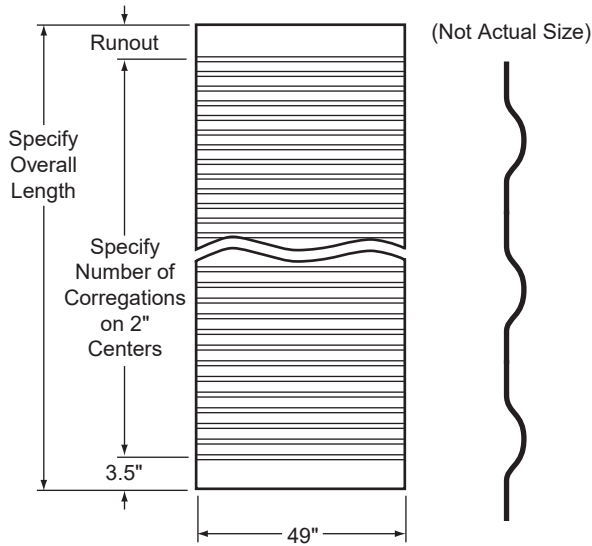

**SIDE PANEL, CORR, PPW**

Stoughton Number
<b>WAB-1C00003</b>

# SCUFF LINERS AND WALL LINERS

Stoughton

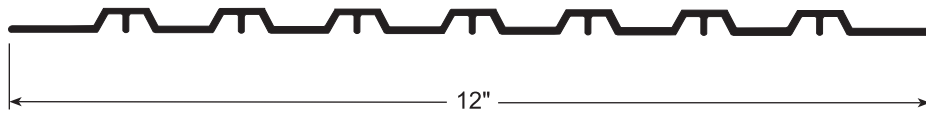

ALUMINUM SCUFF

Stoughton Number	Length	Material	Remarks
02 11885 624 12	624"	6061-T6 Alloy	.080 thickness

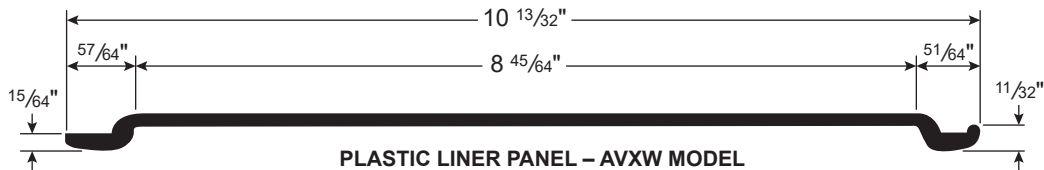

PLASTIC LINER PANEL – AVXW MODEL

Stoughton Number	Width	Length
04 20007 096 00	10.4"	96"

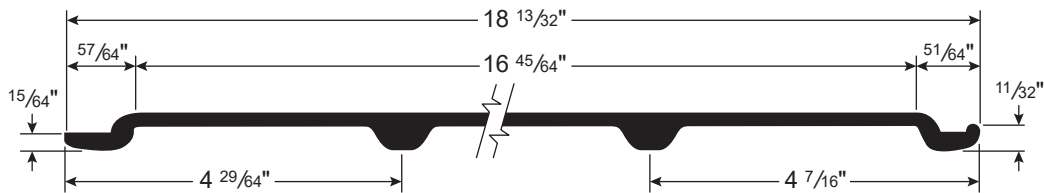

PLASTIC LINER PANEL – AVXW MODEL

Stoughton Number	Width	Length
04 21804 096 00	18.4"	96"

## SCUFF LINERS AND WALL LINERS

Stoughton

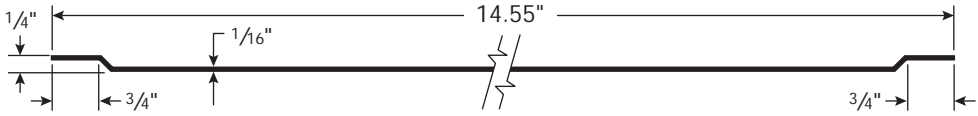

DYMONDPLY FIBERGLASS LINER PANEL – AVXW MODEL

Stoughton Number	Width	Length
04 23727 096 00	14.55"	96"

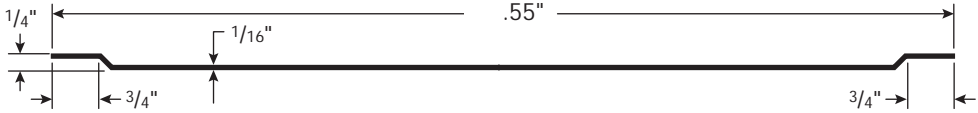

DYMONDPLY FIBERGLASS LINER PANEL – AVXW MODEL

Stoughton Number	Width	Length
04 23728 096 00	22.55"	96"

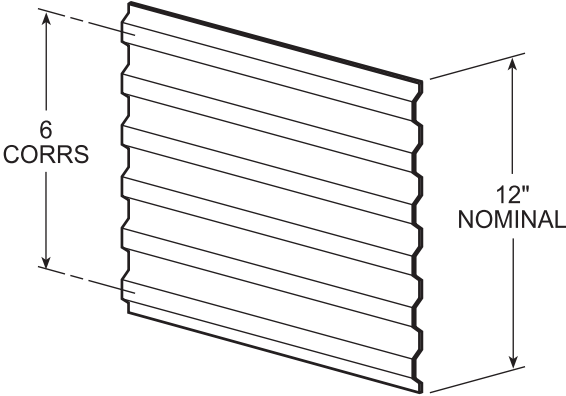

CORRUGATED SCUFF

Stoughton Number	Length
04 85090 564 12	564"
04 85090 624 12	624"

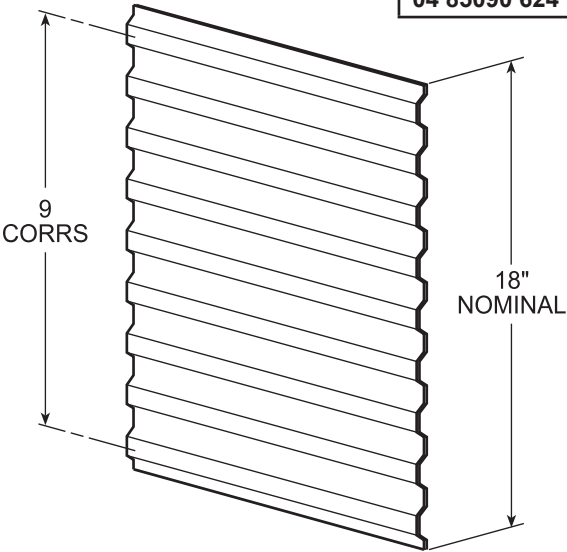

"TUF-SCUF"

Stoughton Number	Length
04 85102 564 18	564"
04 85102 624 18	624"

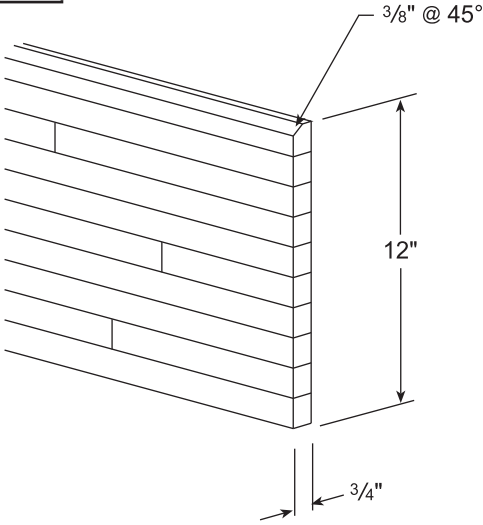

HARDWOOD SCUFF

Stoughton Number	Length
04 85275 620 00	624"

## SCUFF LINERS AND WALL LINERS

Stoughton

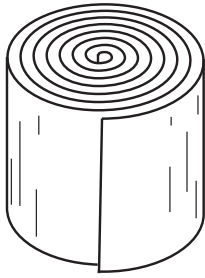

### FIBERGLASS SCUFF LINERS – KEMLITE

Stoughton Number	Description
<b>CKAFS 12X53</b>	.090 Thick x 12" x 53' Scuff Band
<b>CKAFS 16X48</b>	.090 Thick x 16" x 48' Scuff Band
<b>CKAFS 16X53</b>	.090 Thick x 16" x 53' Scuff Band
<b>CKAFS 24X48</b>	.090 Thick x 24" x 48' Scuff Band
<b>CKAFS 24X53</b>	.090 Thick x 24" x 53' Scuff Band
<b>CKAFS 48X8</b>	.090 Thick x 48" x 96" Scuff Band
<b>CKFAS 48X9</b>	.090 Thick x 48" x 108" Scuff Band
<b>CKAFS 48X48</b>	.090 Thick x 48" x 48' Scuff Band
<b>CKAFS 48X53</b>	.090 Thick x 48" x 53' Scuff Band
<b>CKBES385X96X53</b>	.090 Thick x 96" Wall Liner – Precut to 624"
<b>CKBES385X96X100</b>	.090 Thick x 96" Wall Liner – Precut to 100'
<b>CKBES485X12X53</b>	.125 Thick x 12" x 53' Scuff Plate

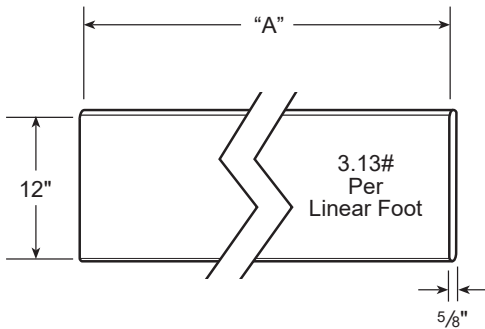

### PLASTIC SCUFF

Stoughton Number	Color	"A"	Remarks
<b>ETSCUFF 12X28</b>	Black	28'	Beveled Top Edge
<b>ETSCUFF 12X53</b>	Black	52'	Beveled Top Edge
<b>ETSCUFF 18X48WT</b>	White	48'	Beveled Top Edge
<b>ETSCUFF 18X52BL</b>	Black	52'	Beveled Top Edge
<b>ETSCUFF 18X53WT</b>	White	52'	Beveled Top Edge
<b>ETSCUF 5/8" 53WT</b>	White	52'	Beveled Top Edge
<b>ETSCUF 3/8" 52BL</b>	Black	52'	Lo-Pro

Sold in rolls. Call for other Scuff items available in plastic.

Stoughton Number	Length	Remarks
<b>ETSCUFF Z BLK</b>	52"	Black
<b>ETSCUFF Z WHT</b>	52"	White



## MISCELLANEOUS Stoughton

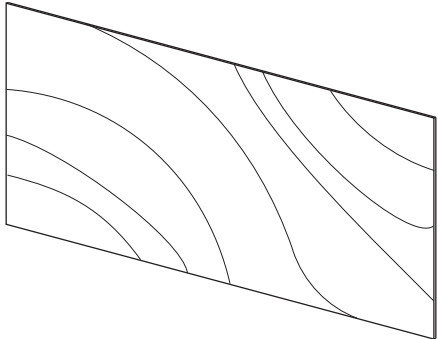

**Note:** Our aftermarket plywood liner is the same product we install in our new trailers. It is not lumberyard plywood.

**PLYWOOD LINING**

Stoughton Number	Size	Grade	Remarks
04 92001 000 00	1/4" x 48" x 96"	B C	132 per Skid



**PLYWOOD DIVIDER**

Stoughton Number	Length	Remarks
AP 78491	96"	Plastic

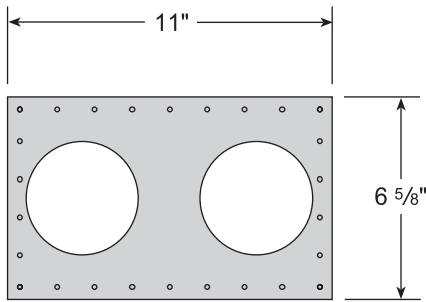

**CARGO CUPS**

Stoughton Number	Remarks
04 14722 000 00	Cover
04 85625 001 00	J.B. Hunt with O-Ring

**SIDEWALL SKYLITE  
(with translucent panel)**

Stoughton Number	Remarks
01 22238 000 00	Cover Panel
04 85708 001 00	Lens

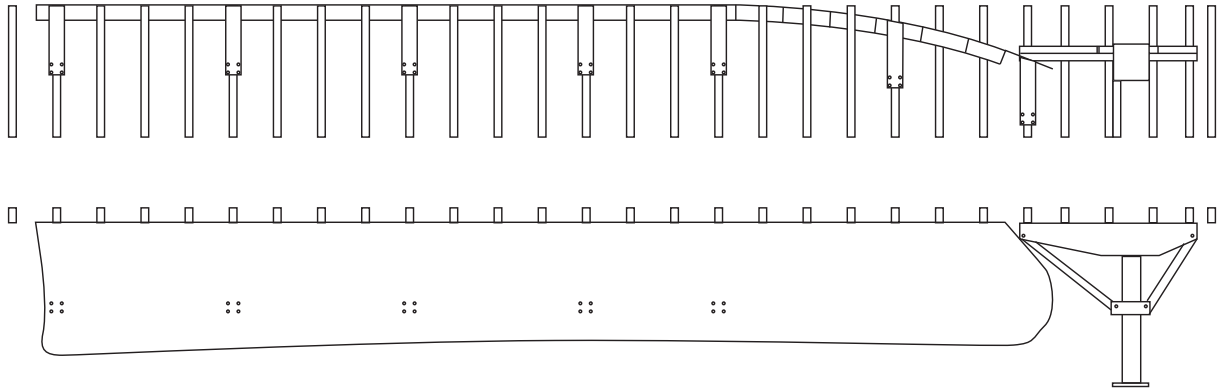

**SIDE SKIRT, GENERATION 2 GREENWING\***

Stoughton Number
04 86970 004 00

\* Part number represents two skirts and all hardware necessary to install on one 53' van.

